

# BAKER HALL EAST

## WASTE INSTRUCTIONS

**1.** Obtain black garbage bags from your front desk for your personal trash can. Do not use any bags or liners for your recycling bin

See fig. 1

fig. 1



**2.** Separate trash from recycling

See fig. 2

fig. 2

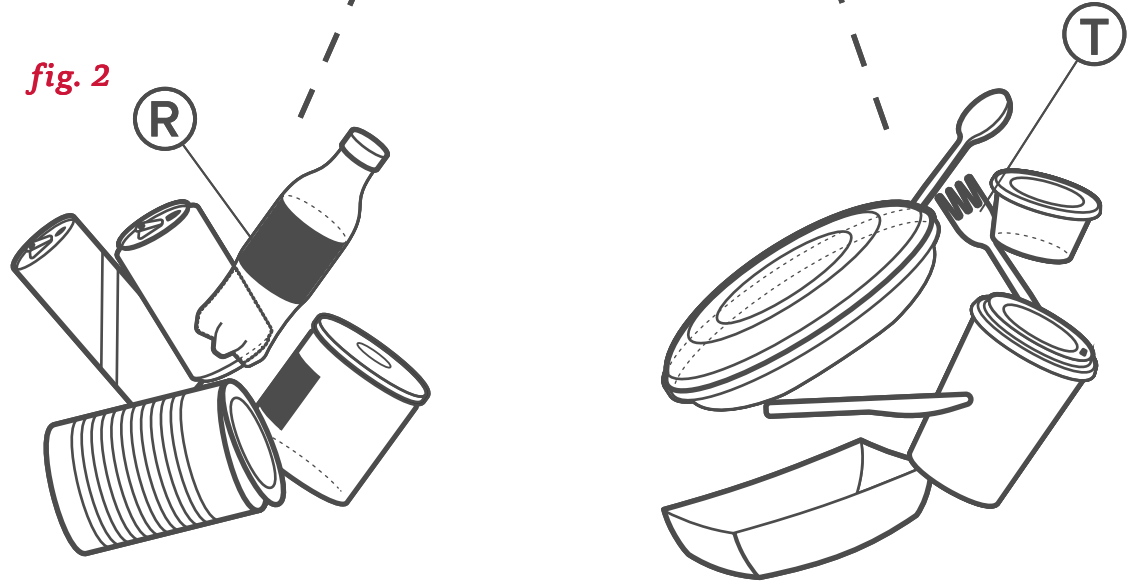

**3.** Take your waste to the bins on your floor outside (1027, 1038, 1071, 2027, 2038, 2071, 3027, 3038, 3071, 4027, 4038, or 4071)

**4.** Place trash and recycling in corresponding containers

See fig. 3

fig. 3

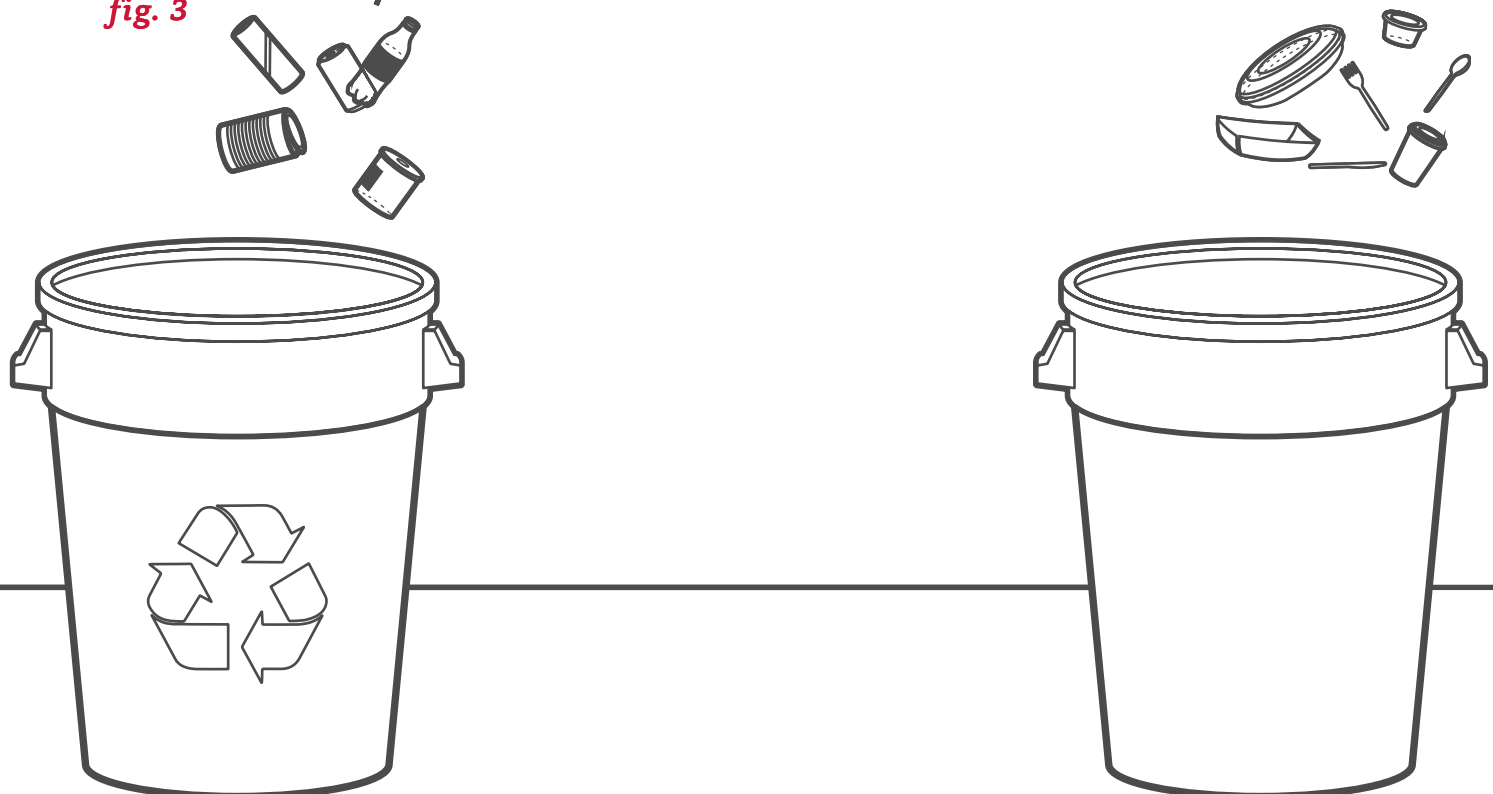

# BAKER HALL WEST

## WASTE INSTRUCTIONS

**1.** Obtain garbage bags from your front desk for your personal trash can. Do not use for your recycling bin

See fig. 1

fig. 1



**2.** Separate trash from recycling

See fig. 2

fig. 2

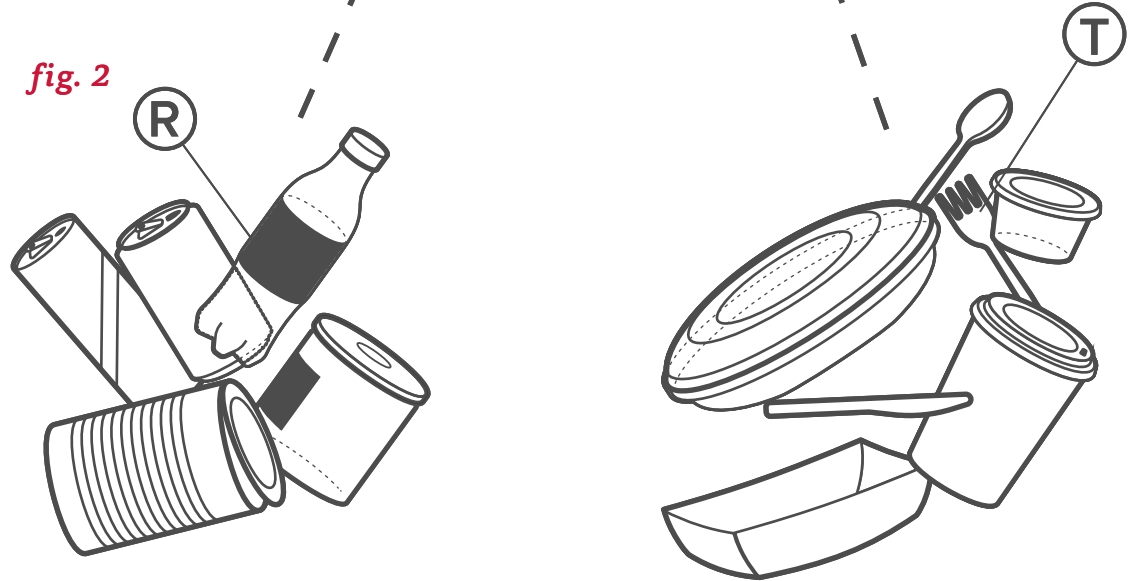

**3.** Take your waste to the bins on your floor outside (1112, 1120, 1148, 2112, 2120, 2148, 3112, 3120, 3148, 4112, 4120, or 4148)

**4.** Place trash and recycling in corresponding containers

See fig. 3

fig. 3

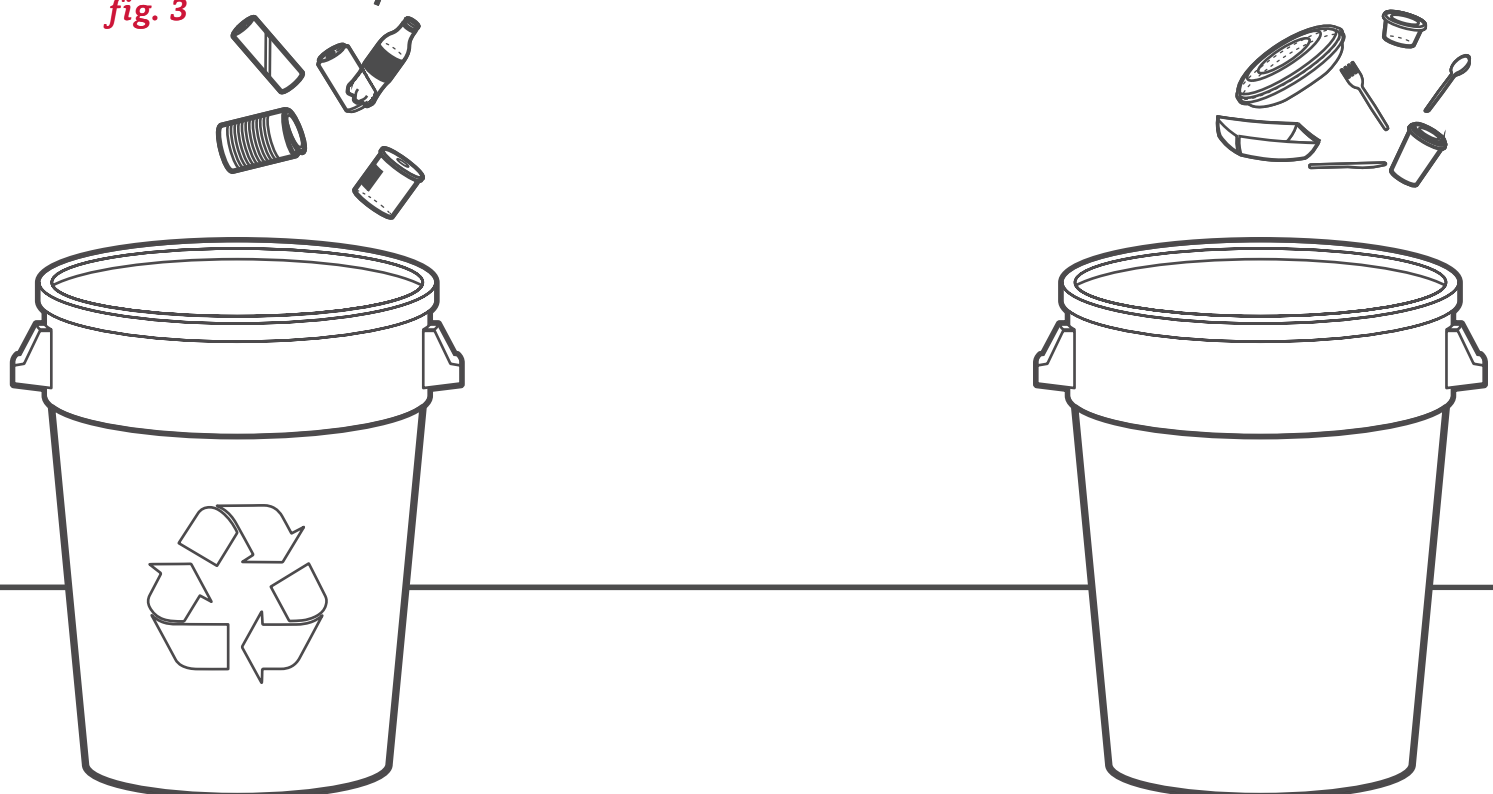

# BRADLEY HALL

## WASTE INSTRUCTIONS

**1.** Obtain garbage bags from your front desk for your personal trash can. Do not use for your recycling bin

See fig. 1

fig. 1



**2.** Separate trash from recycling

See fig. 2

fig. 2

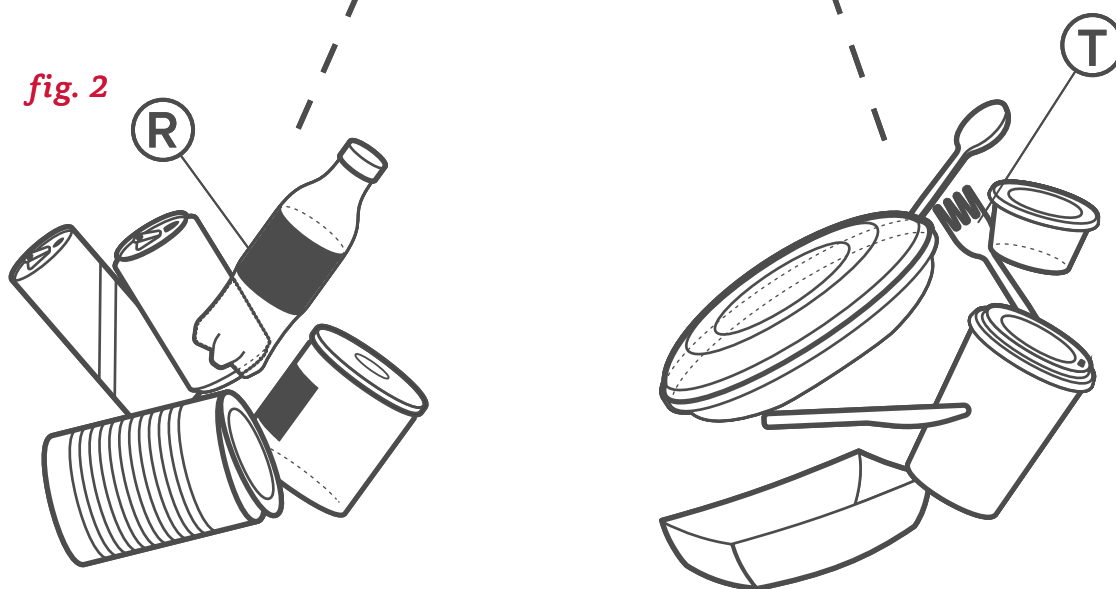

**3.** Take your waste to the bins on your floor near the glass rooms

**4.** Place trash and recycling in corresponding containers

See fig. 3

fig. 3

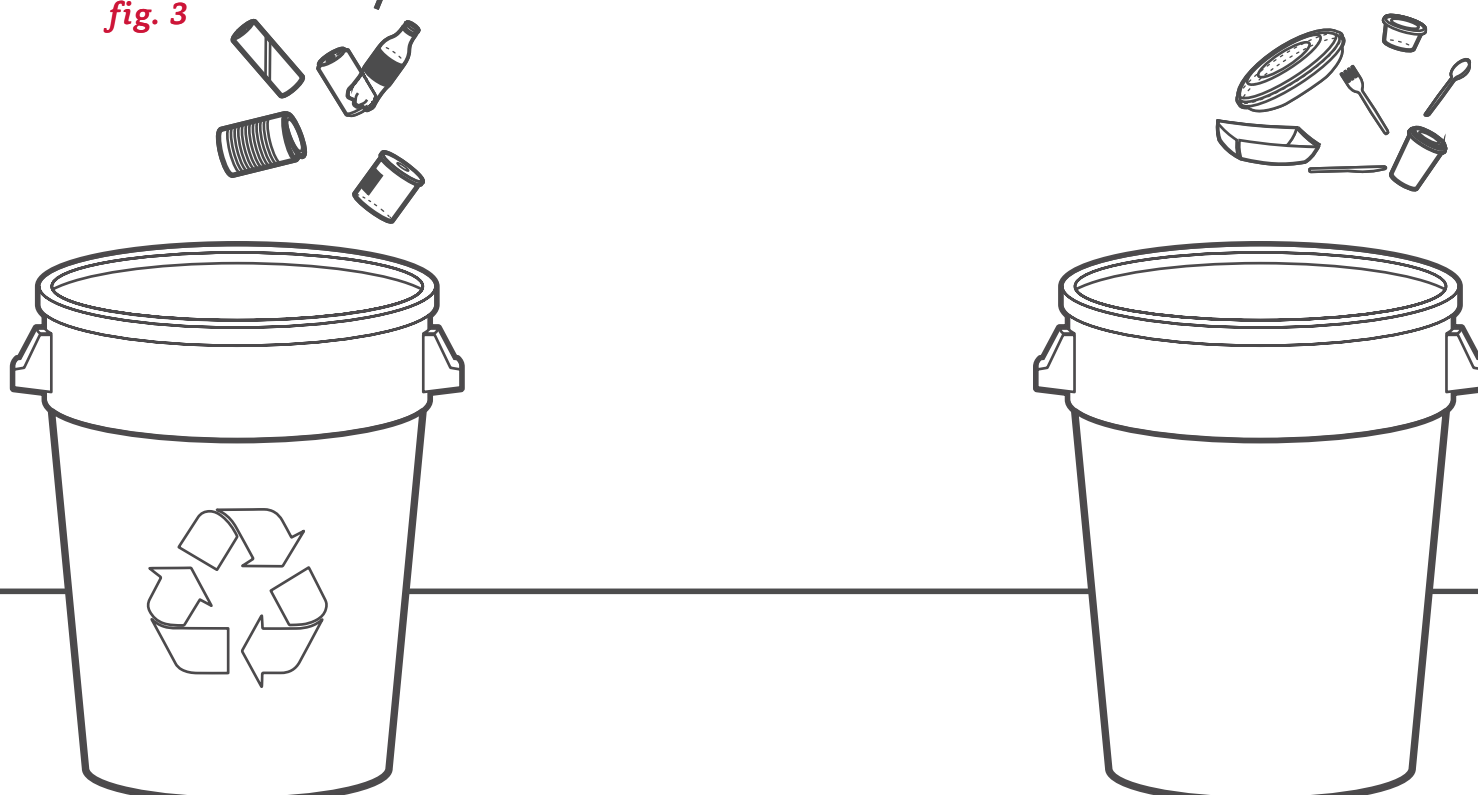

# CANFIELD HALL

## WASTE INSTRUCTIONS

**1.** Obtain garbage bags from your front desk for your personal trash can. Do not use for your recycling bin

See fig. 1

fig. 1



**2.** Separate trash from recycling

See fig. 2

fig. 2

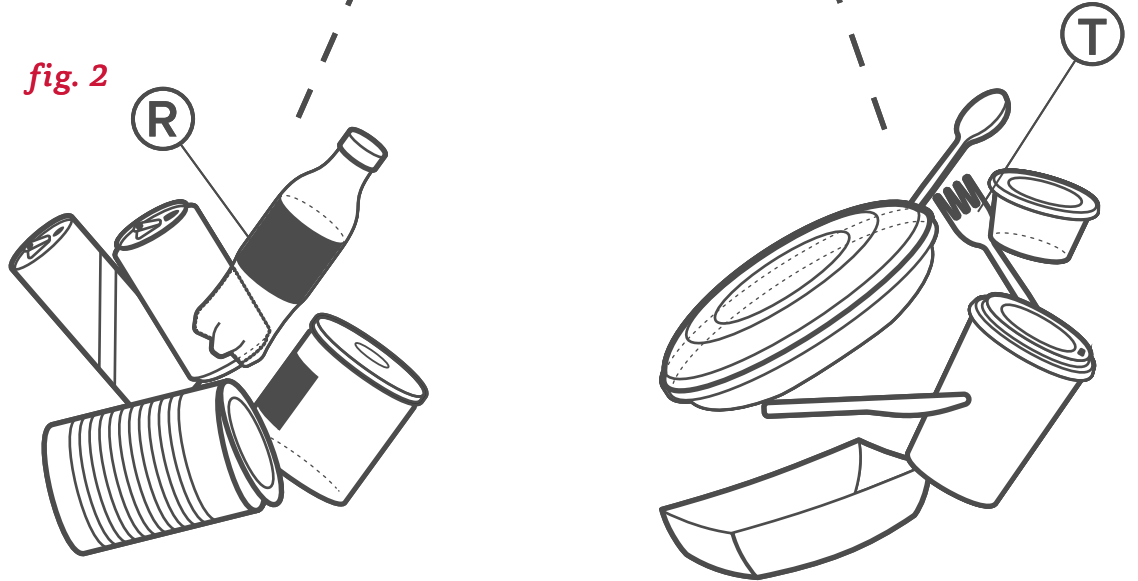

**3.** Take your waste to the trash room on your floor (115, 223, 323, or 423) talk to your environmental services staff members for exact location

**4.** Place trash and recycling in corresponding containers

See fig. 3

fig. 3

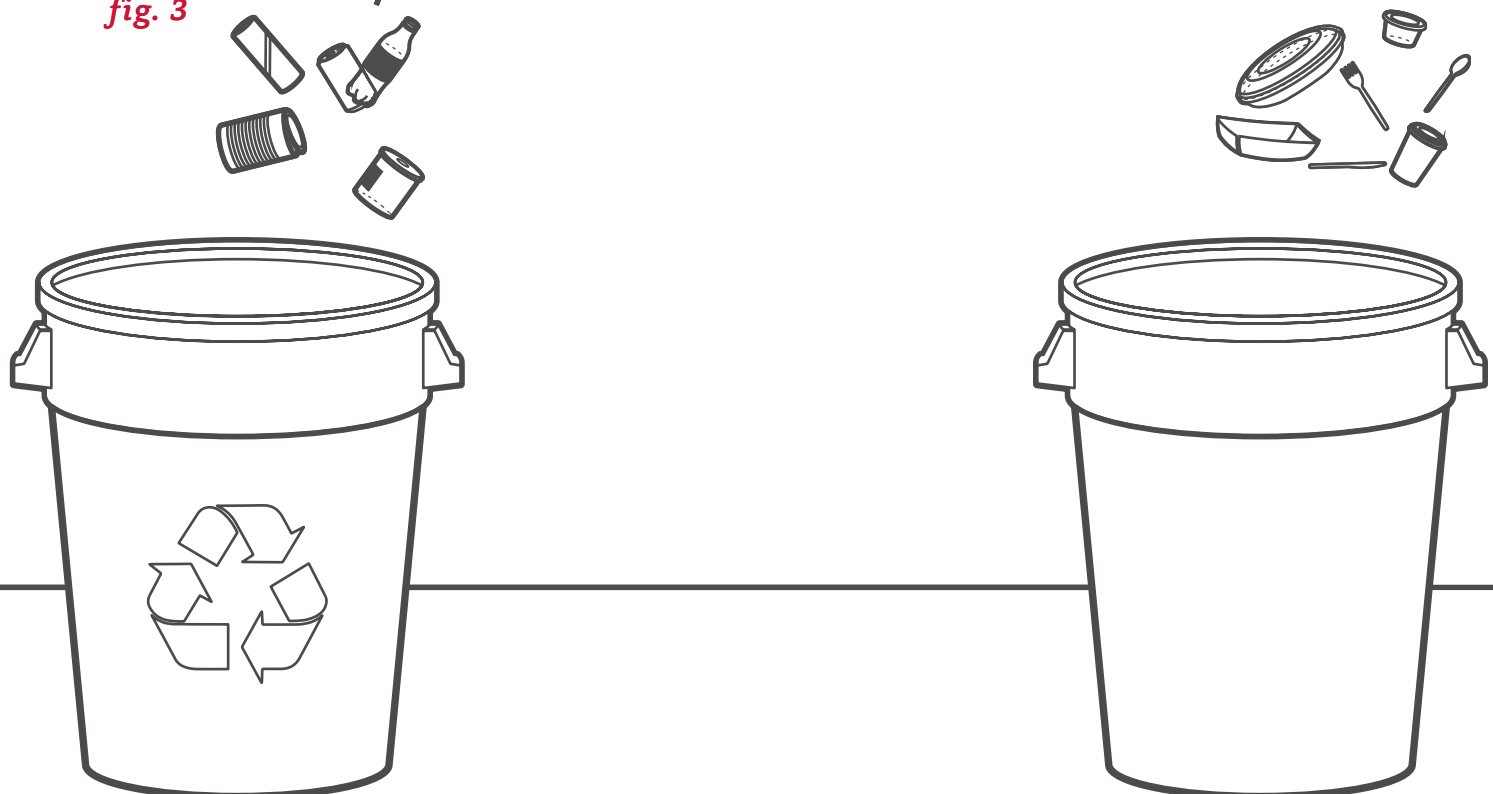

# FECHKO HOUSE

## WASTE INSTRUCTIONS

**1.** Obtain garbage bags from the Neil building front desk (**1578 Neil Ave**) for your personal trash can. Do not use for your recycling bin

See fig. 1

fig. 1



**2.** Separate trash from recycling

See fig. 2

fig. 2

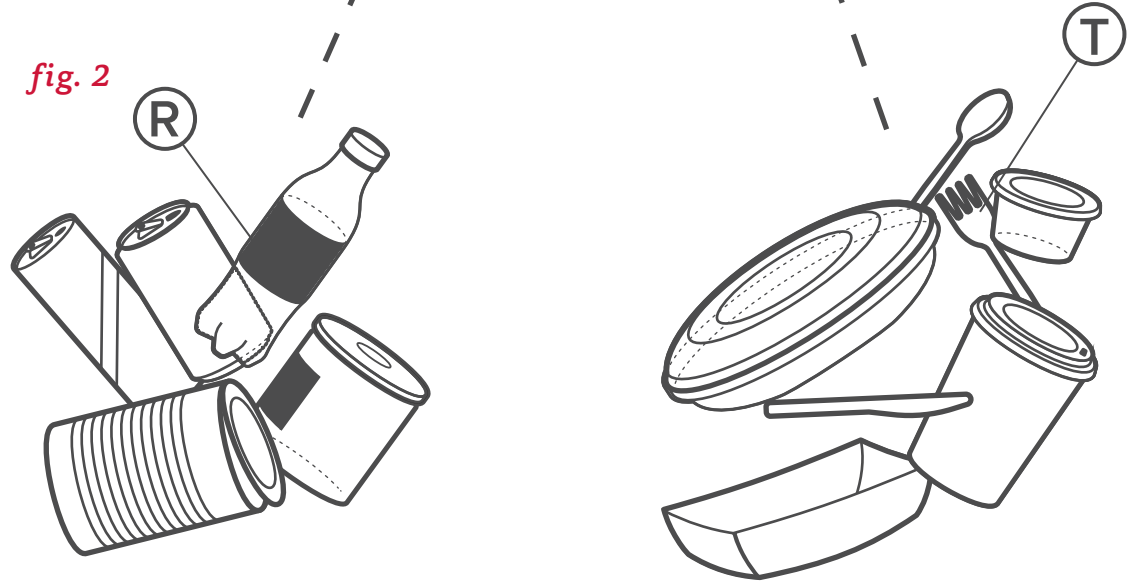

**3.** Go to the first floor and take your waste outside to the dumpster

**4.** Place trash and recycling in corresponding dumpsters

See fig. 3

fig. 3

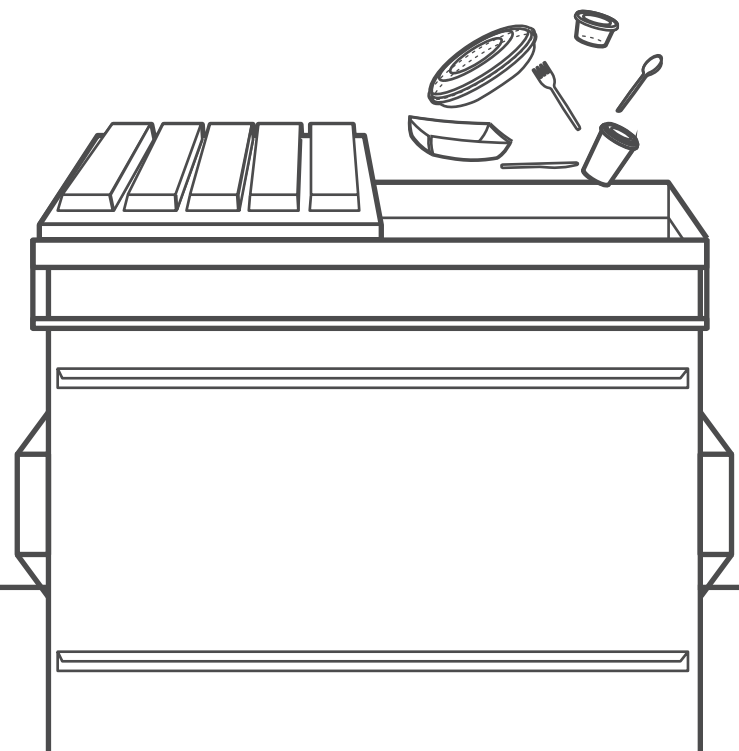
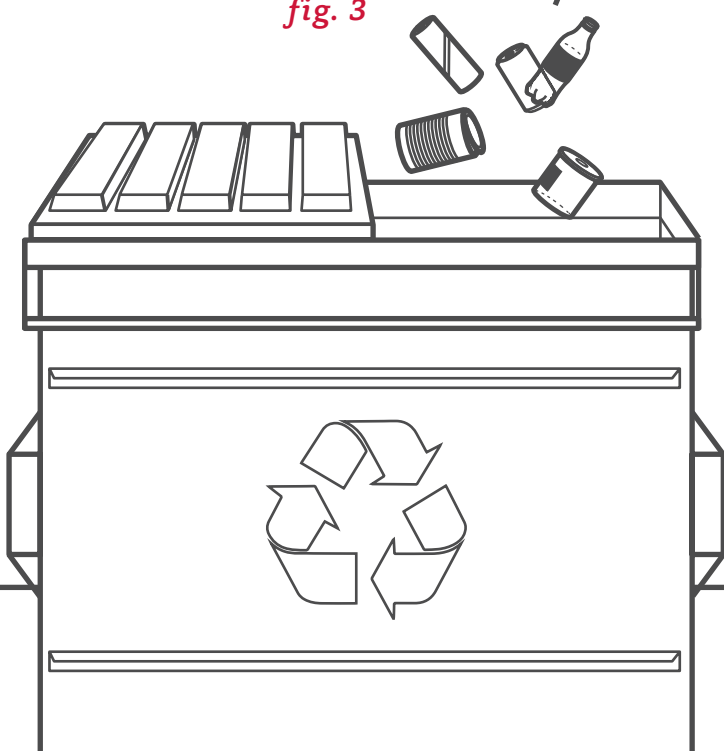

# GERMAN HOUSE

## WASTE INSTRUCTIONS

**1.** Obtain garbage bags from the Neil building front desk (**1578 Neil Ave**) for your personal trash can. Do not use for your recycling bin

See fig. 1

fig. 1



**2.** Separate trash from recycling

See fig. 2

fig. 2

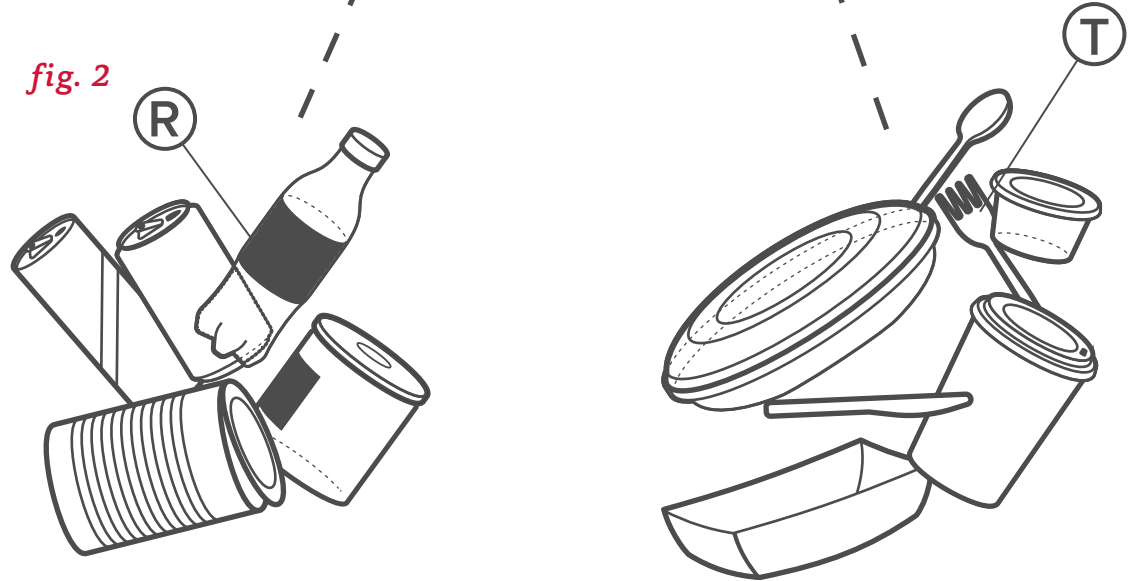

**3.** Go to the first floor and take your waste outside to the dumpster

**4.** Place trash and recycling in corresponding dumpsters

See fig. 3

fig. 3

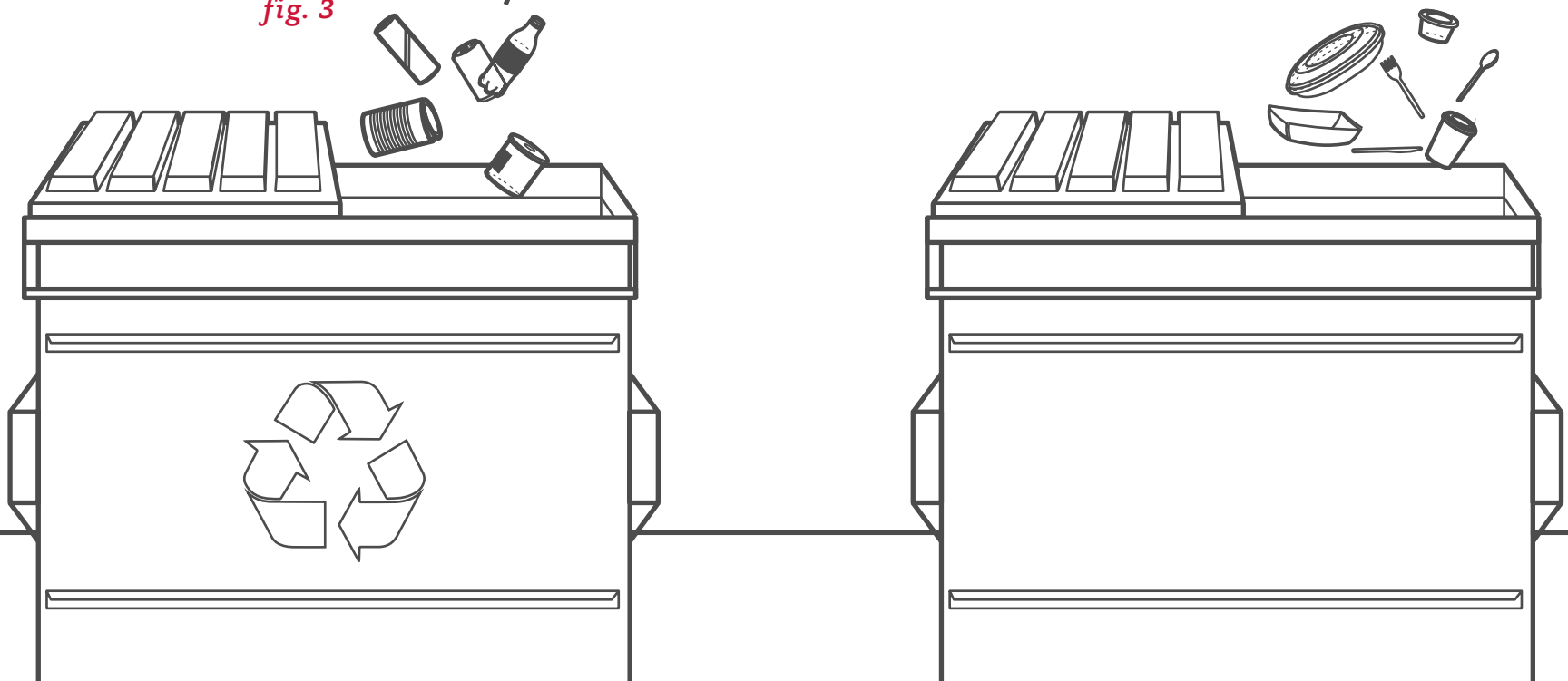



# HANLEY HOUSE

## WASTE INSTRUCTIONS

**1.** Obtain garbage bags from the Neil building front desk (**1578 Neil Ave**) for your personal trash can. Do not use for your recycling bin

See fig. 1

fig. 1



**2.** Separate trash from recycling

See fig. 2

fig. 2

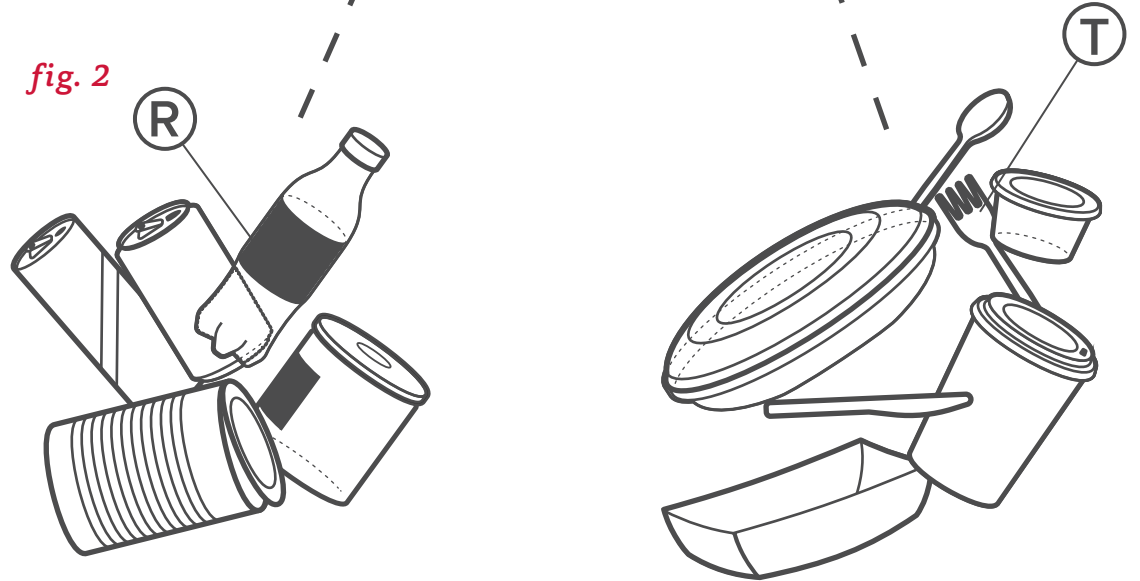

**3.** Go to the first floor and take your waste outside to the dumpster

**4.** Place trash and recycling in corresponding dumpsters

See fig. 3

fig. 3

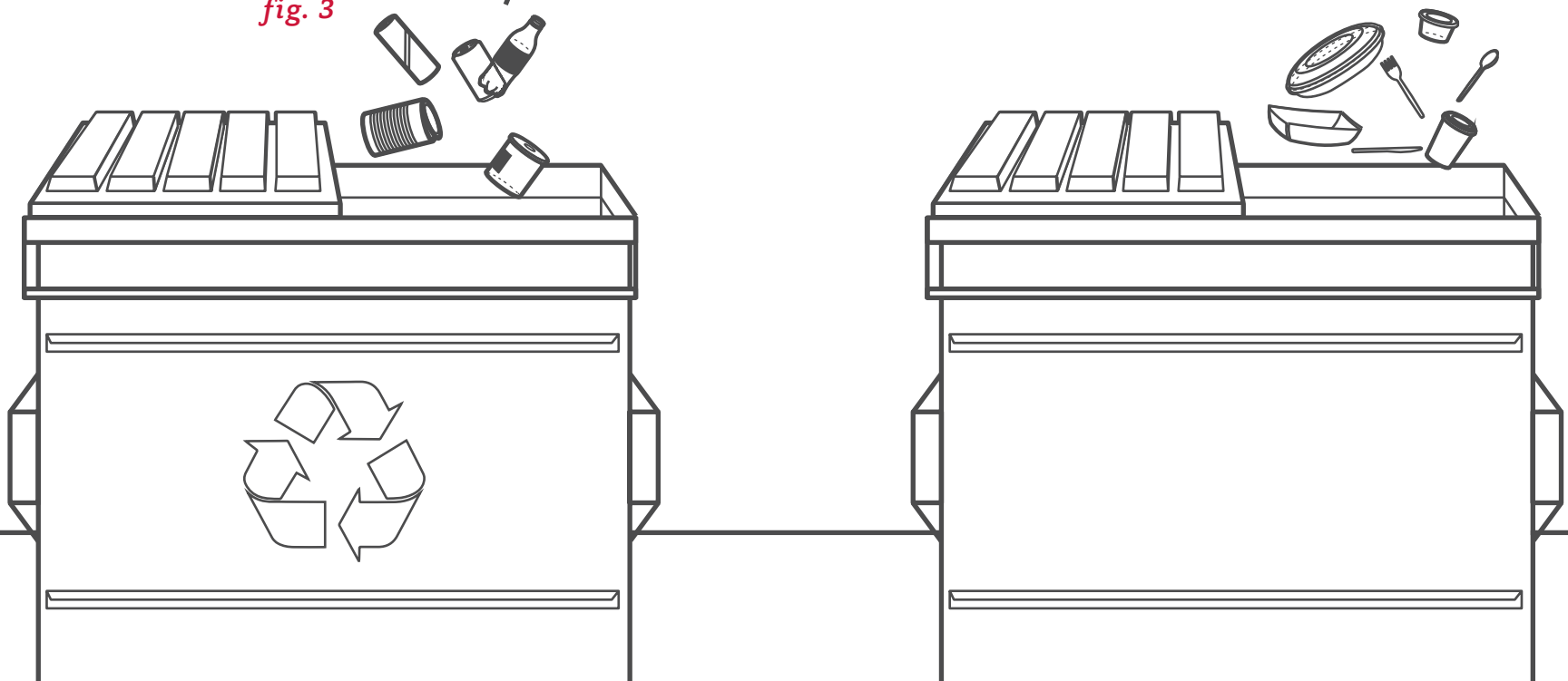

# MACK HALL

## WASTE INSTRUCTIONS

**1.** Obtain garbage bags from your front desk for your personal trash can. Do not use for your recycling bin

See fig. 1

fig. 1



**2.** Separate trash from recycling

See fig. 2

fig. 2

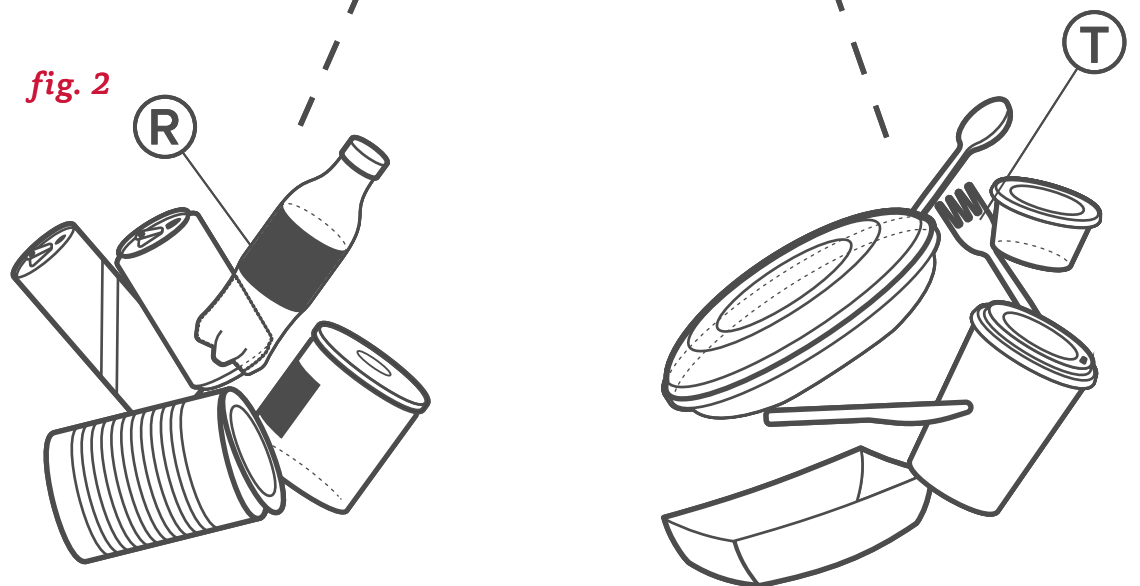

**3.** Take your waste to the bins in the hallway on your floor

**4.** Place trash and recycling in corresponding containers

See fig. 3

fig. 3

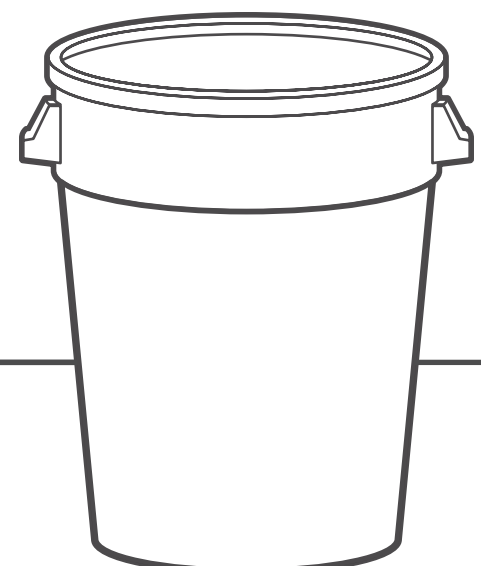
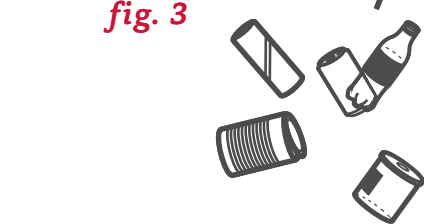



# MORRISON TOWER

## WASTE INSTRUCTIONS

**1.** Obtain garbage bags from your front desk for your personal trash can. Do not use for your recycling bin

See fig. 1

fig. 1



**2.** Separate trash from recycling

See fig. 2

fig. 2

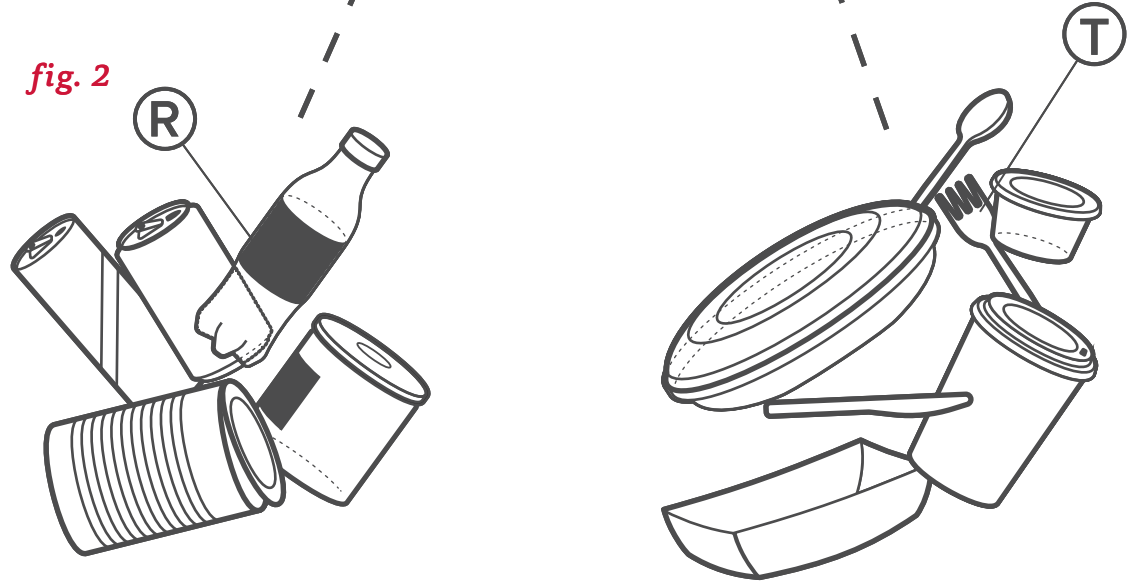

**3.** Take your waste to the trash room on your floor (119, 219, 319, 419, 519, 619, 719, 819, 919, or 1019)

**4.** Place trash and recycling in corresponding containers

See fig. 3

fig. 3

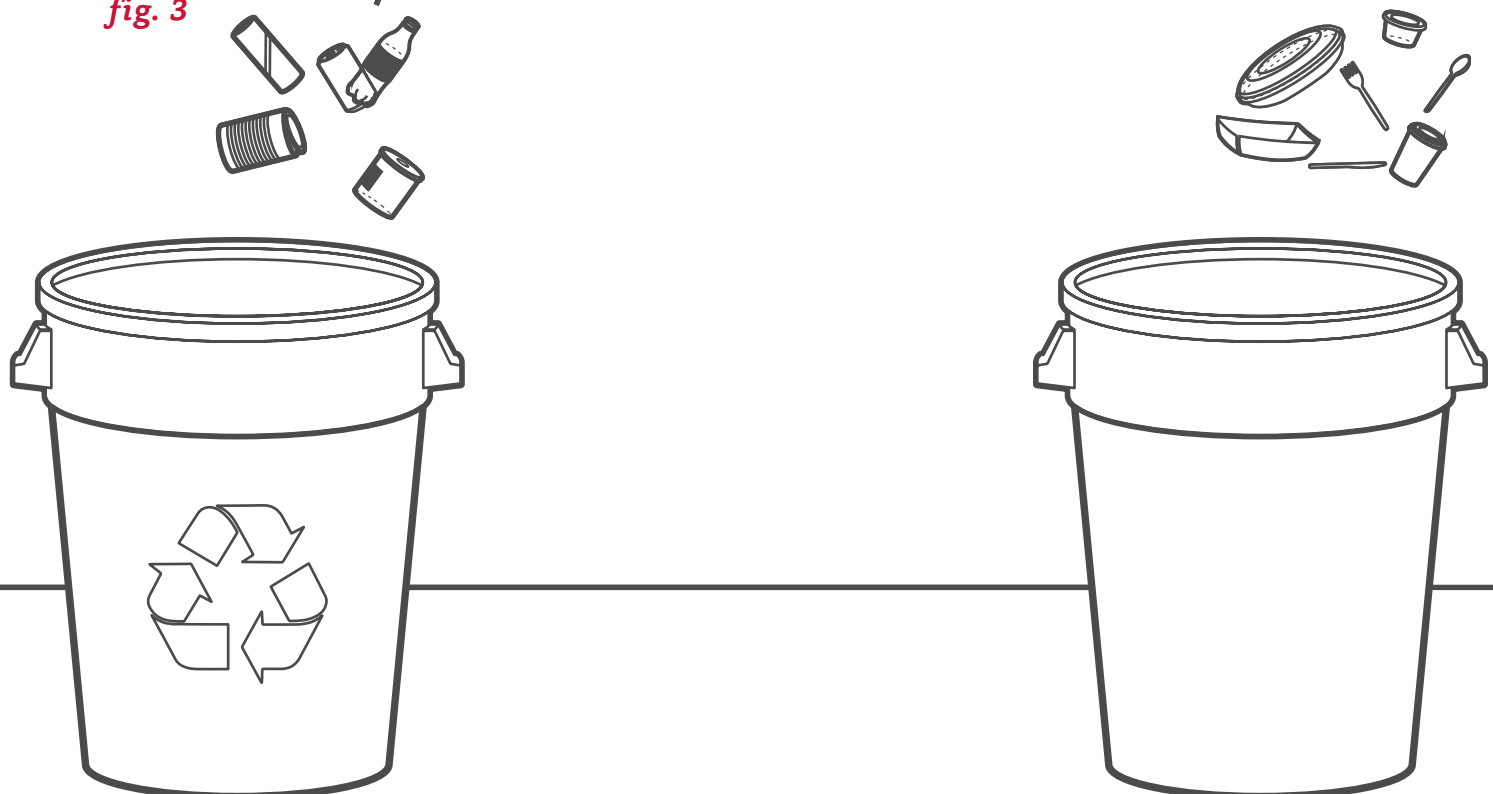

# NEIL AVENUE BUILDING

## WASTE INSTRUCTIONS

**1.** Obtain garbage bags from your front desk for your personal trash can. Do not use for your recycling bin

See fig. 1

fig. 1



**2.** Separate trash from recycling

See fig. 2

fig. 2

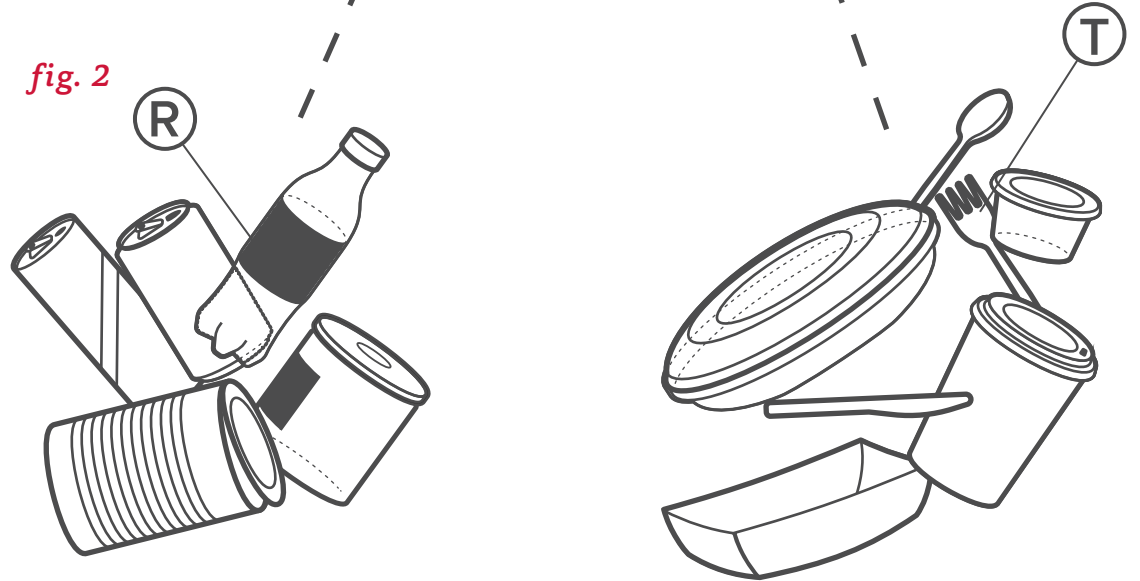

**3.** Go downstairs to the first floor and take your waste outside to the dumpster

**4.** Place trash and recycling in corresponding dumpsters

See fig. 3

fig. 3

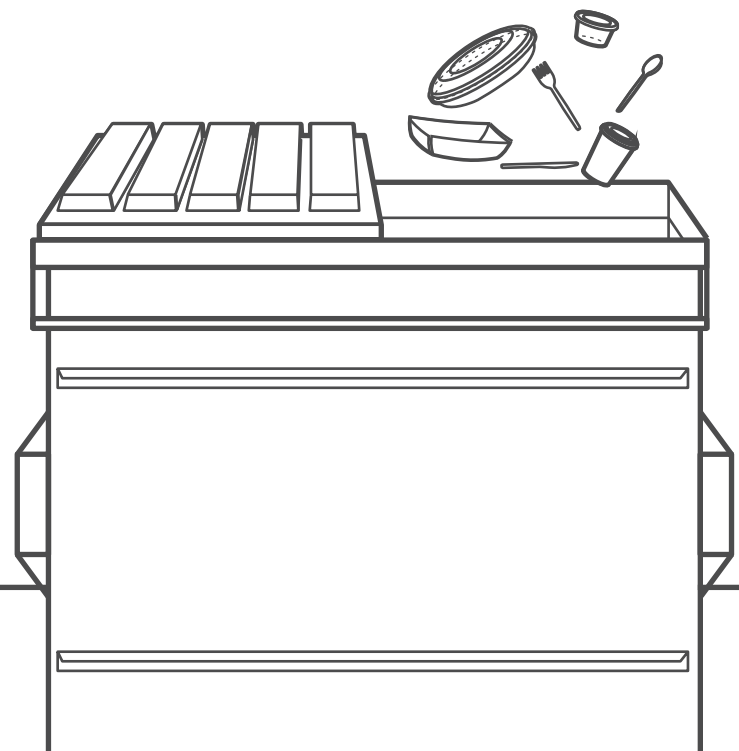
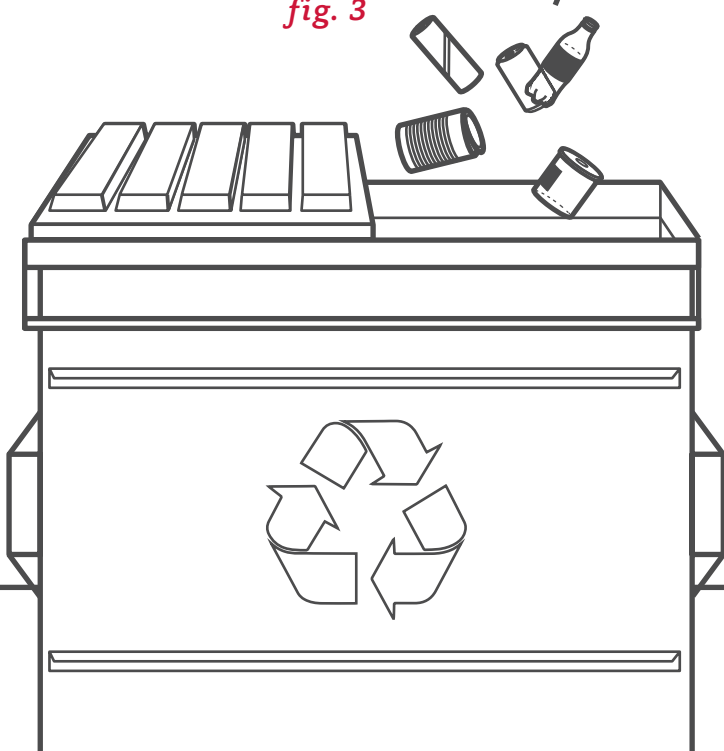

# PARK-STRADLEY HALL

## WASTE INSTRUCTIONS

**1.** Obtain garbage bags from your front desk for your personal trash can. Do not use for your recycling bin

See fig. 1

fig. 1



**2.** Separate trash from recycling

See fig. 2

**3.** Go downstairs to the first floor and take your waste outside to the dumpster on the **11<sup>th</sup> ave.** side

**4.** Place recycling in **red** dumpster

**5.** Put trash in the side door of the brown compactor. Please do not put it on the top of the compactor; there is no opening there

See fig. 3

fig. 2

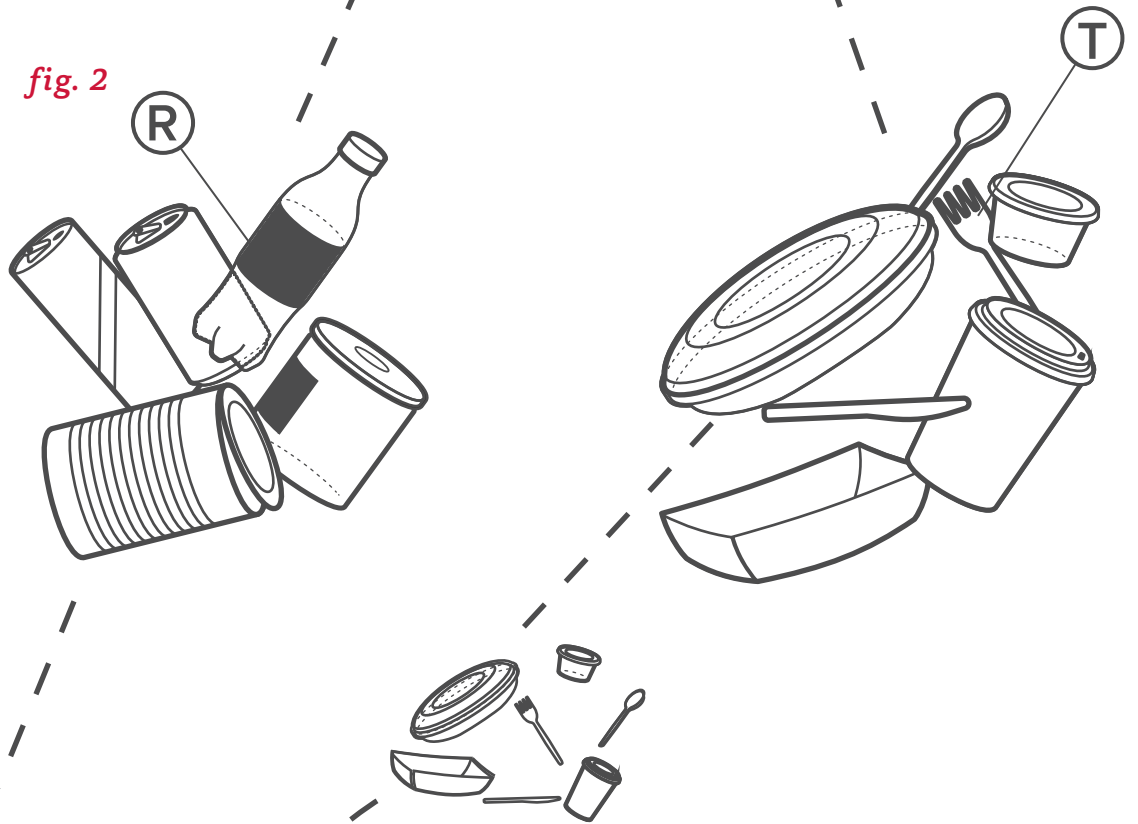
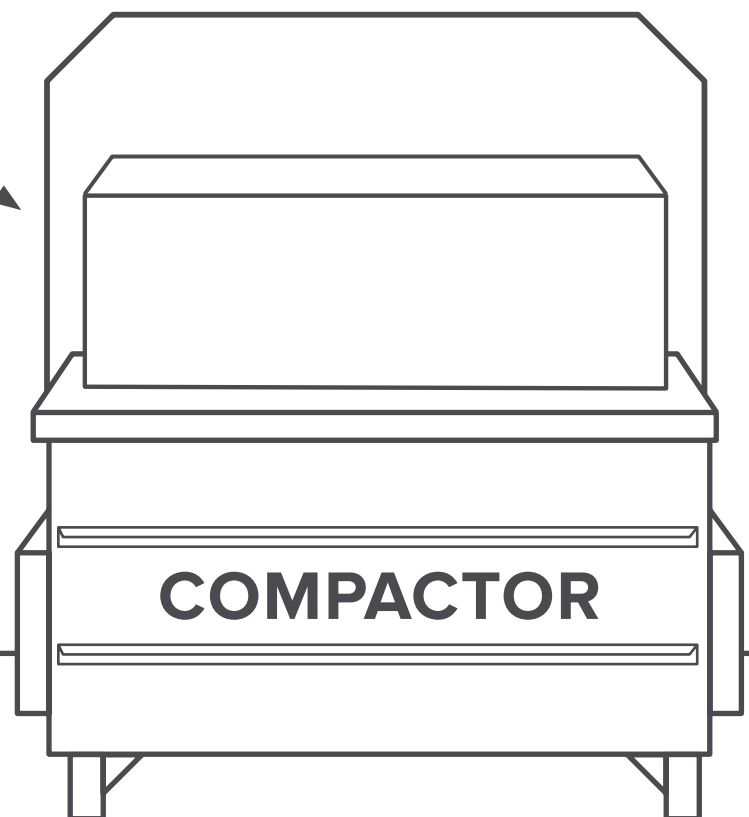
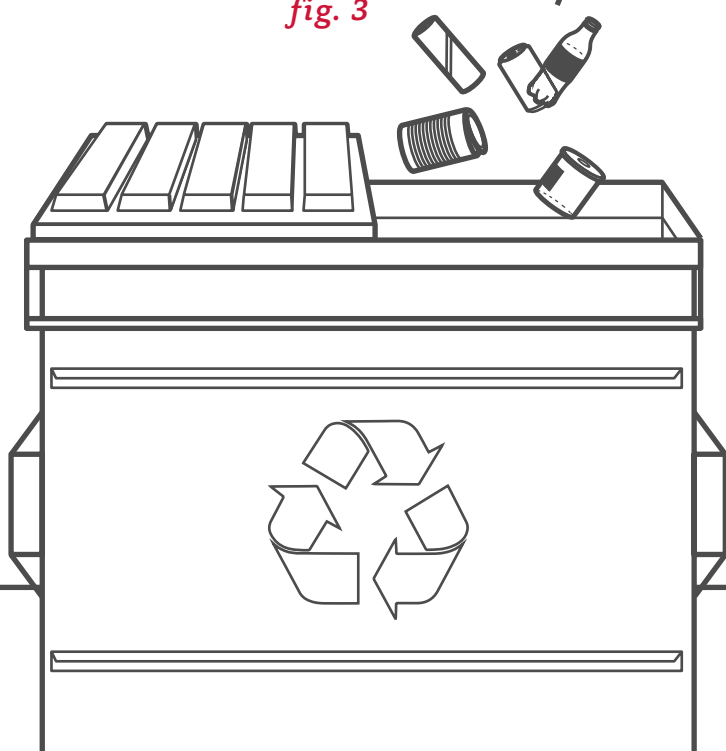

fig. 3



# PATERSON HALL

## WASTE INSTRUCTIONS

**1.** Obtain garbage bags from your front desk for your personal trash can. Do not use for your recycling bin

See *fig. 1*

*fig. 1*



**2.** Separate trash from recycling

See *fig. 2*

*fig. 2*

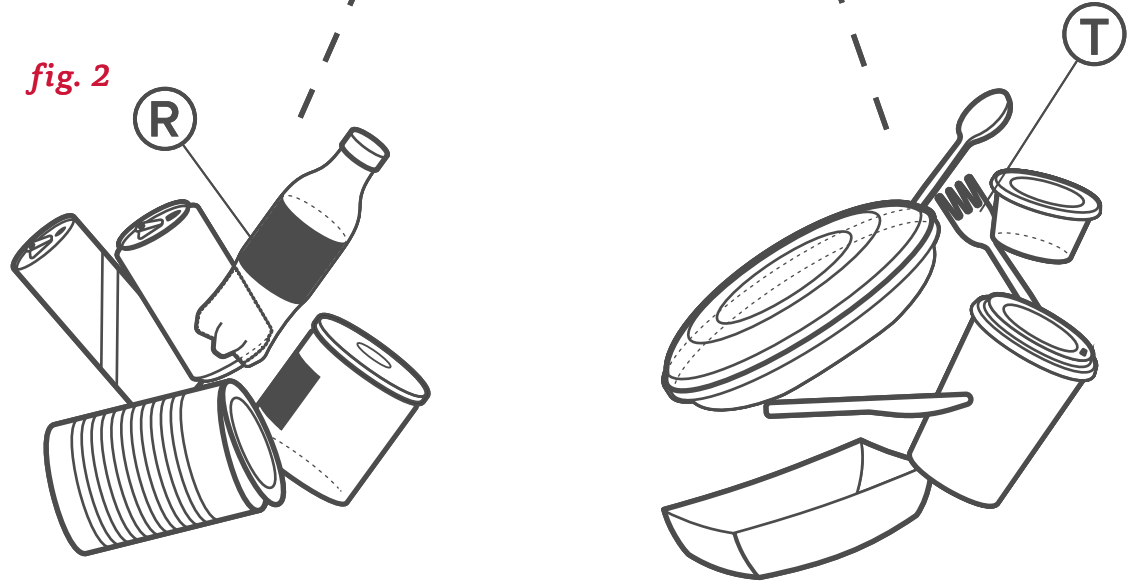

**3.** Take your waste to the bins on your floor near the glass rooms

**4.** Place trash and recycling in corresponding containers

See *fig. 3*

*fig. 3*

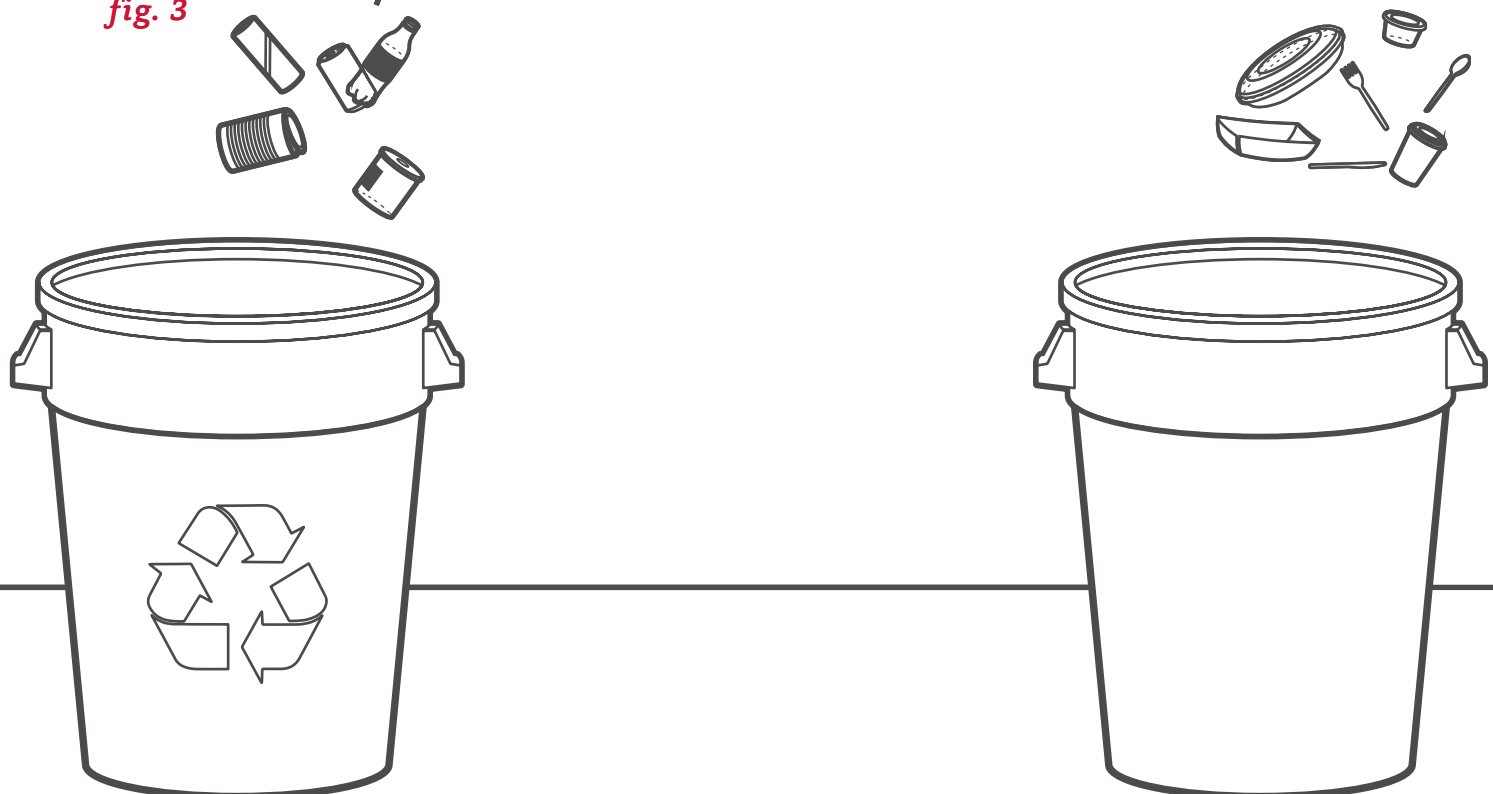

# PENNSYLVANIA PLACE

## WASTE INSTRUCTIONS

**1.** Obtain garbage bags from the Neil building front desk (**1578 Neil Ave**) for your personal trash can. Do not use for your recycling bin

See fig. 1

fig. 1



**2.** Separate trash from recycling

See fig. 2

fig. 2

**3.** Go to the first floor and take your waste outside to the dumpster near the parking lot

**4.** Place trash and recycling in corresponding dumpsters

See fig. 3

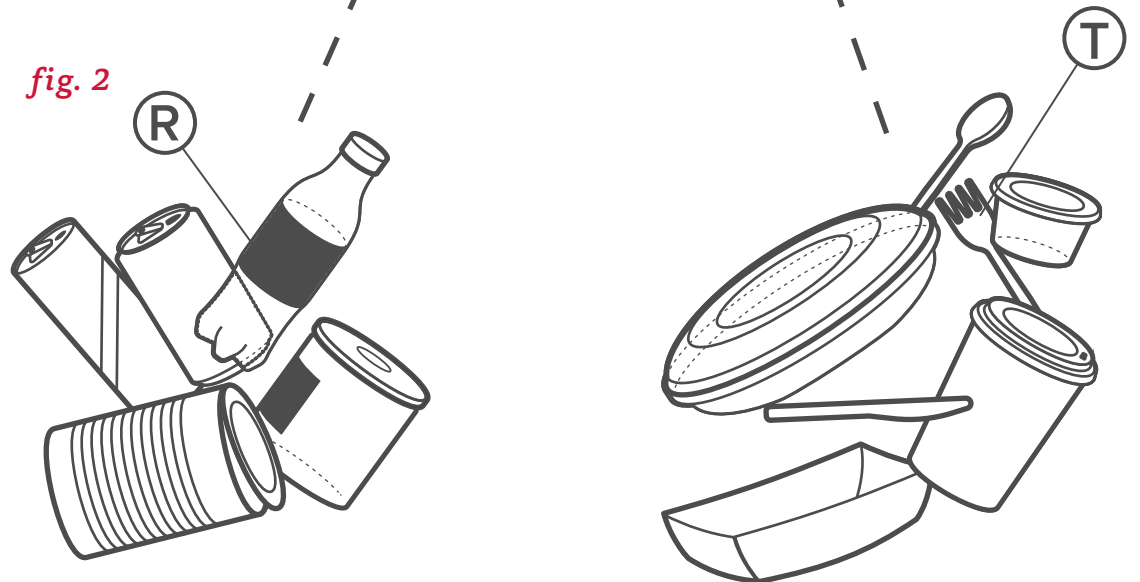
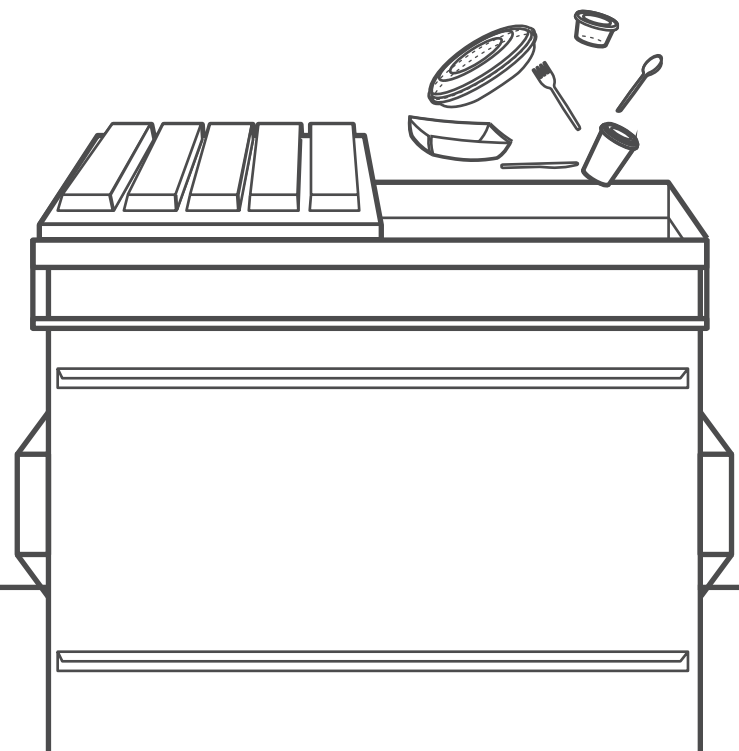
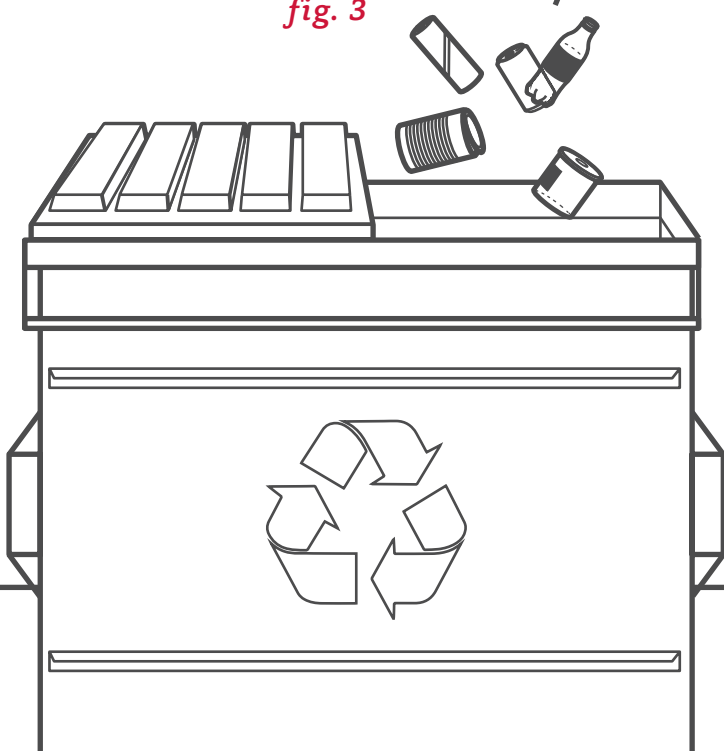

fig. 3



# POMERENE HOUSE

## WASTE INSTRUCTIONS

**1.** Obtain garbage bags from the Neil building front desk (**1578 Neil Ave**) for your personal trash can. Do not use for your recycling bin

See fig. 1

fig. 1



**2.** Separate trash from recycling

See fig. 2

fig. 2

**3.** Go to the first floor and take your waste outside to the dumpster by the parking lot

**4.** Place trash and recycling in corresponding dumpsters

See fig. 3

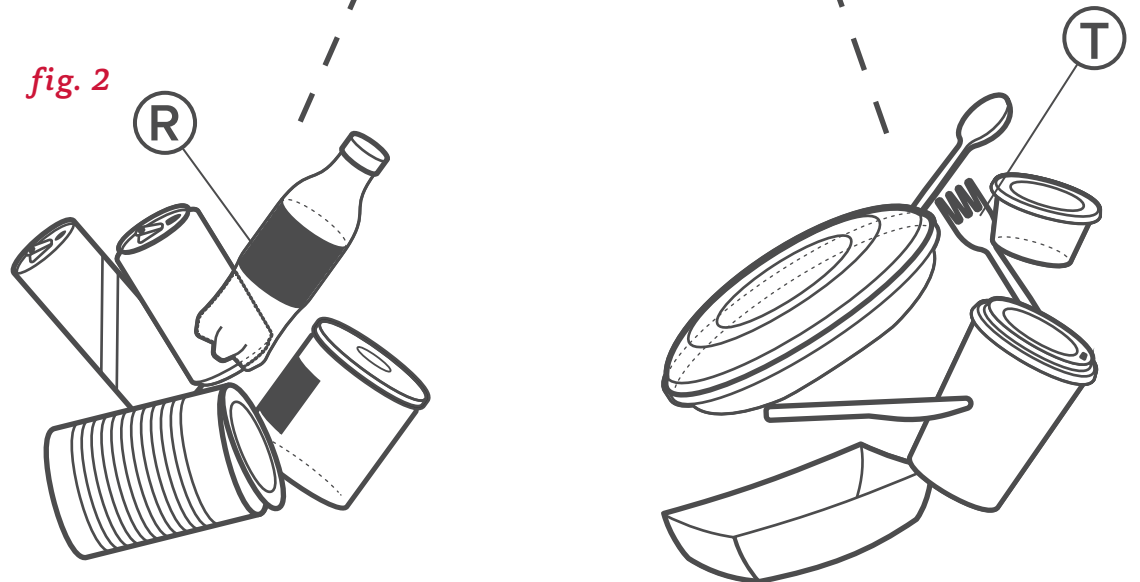
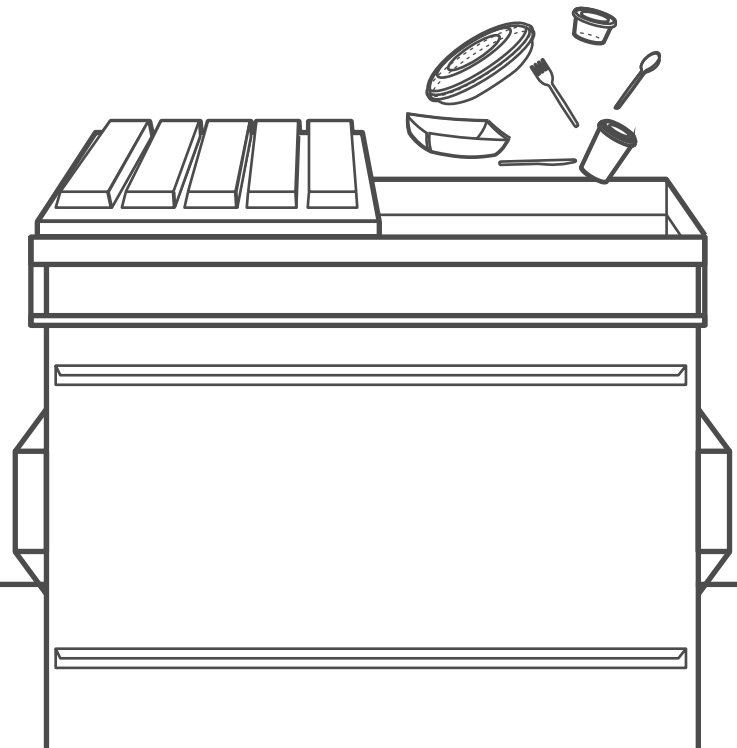
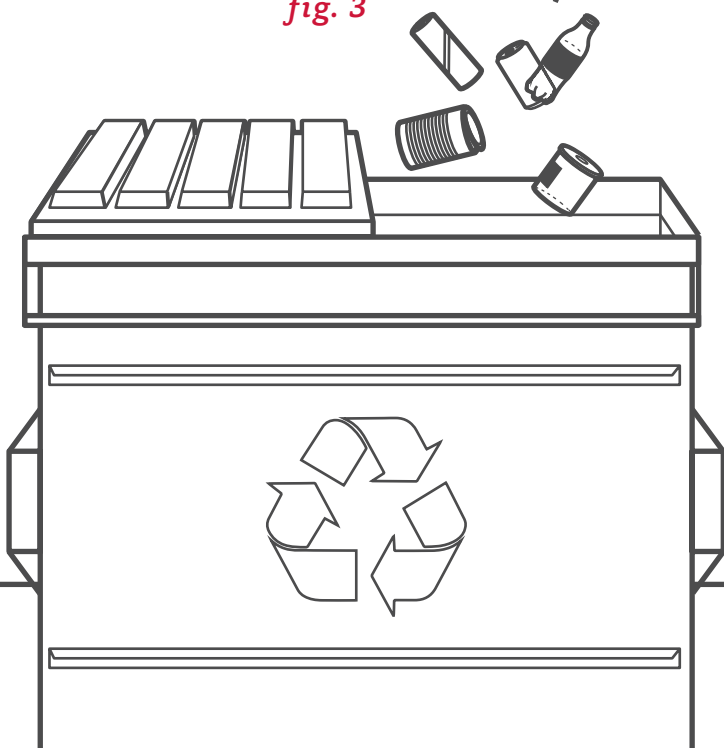

fig. 3





# SCHOLARS EAST

## WASTE INSTRUCTIONS

**1.** Obtain garbage bags from the Neil building front desk (**1578 Neil Ave**) for your personal trash can. Do not use for your recycling bin

See fig. 1

fig. 1



**2.** Separate trash from recycling

See fig. 2

fig. 2

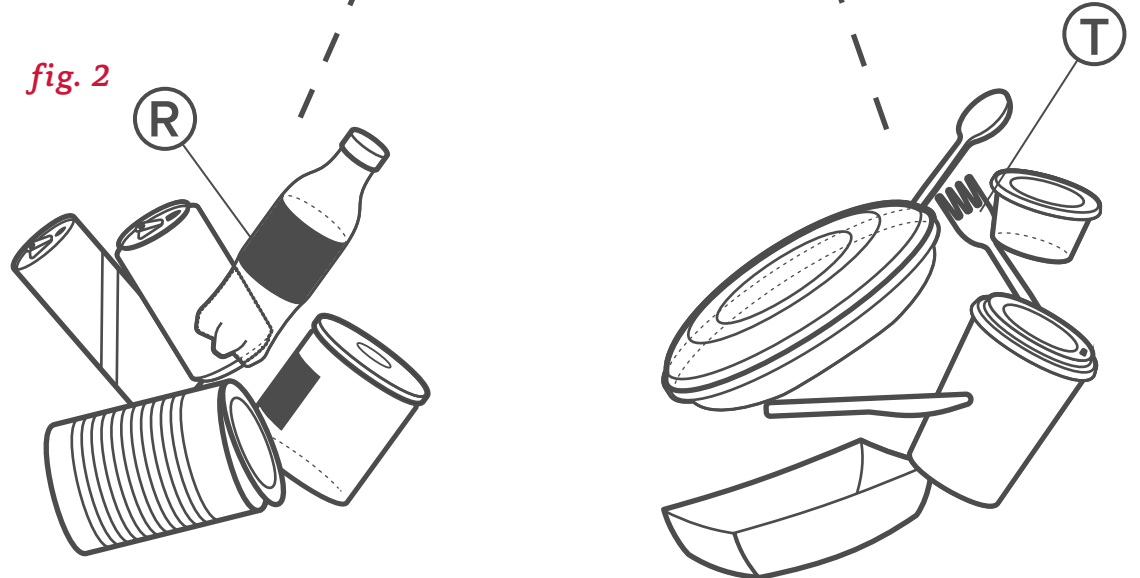

**3.** Go to the first floor and take your waste outside to the dumpster by the parking lot

**4.** Place trash and recycling in corresponding dumpsters

See fig. 3

fig. 3

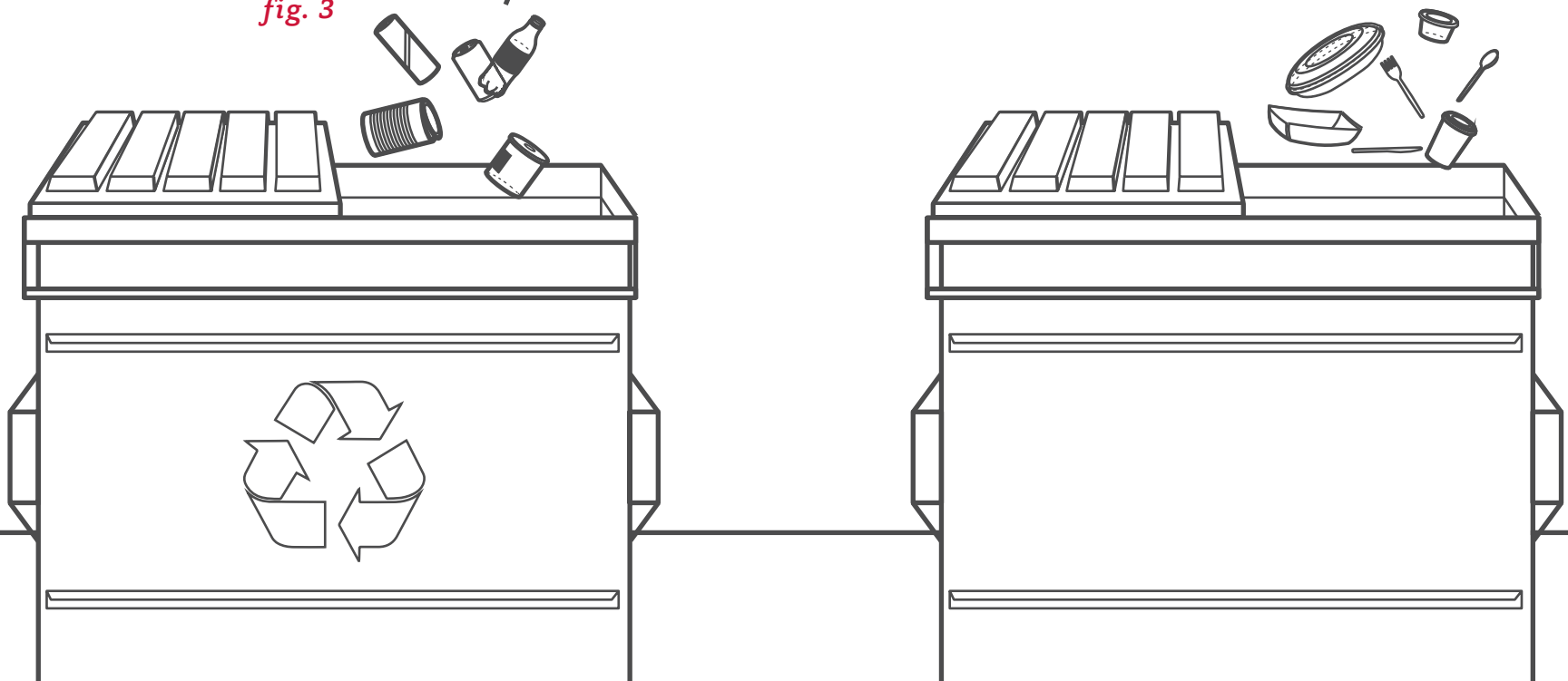

# SCHOLARS WEST

## WASTE INSTRUCTIONS

**1.** Obtain garbage bags from the Neil building front desk (**1578 Neil Ave**) for your personal trash can. Do not use for your recycling bin

See fig. 1

fig. 1



**2.** Separate trash from recycling

See fig. 2

fig. 2

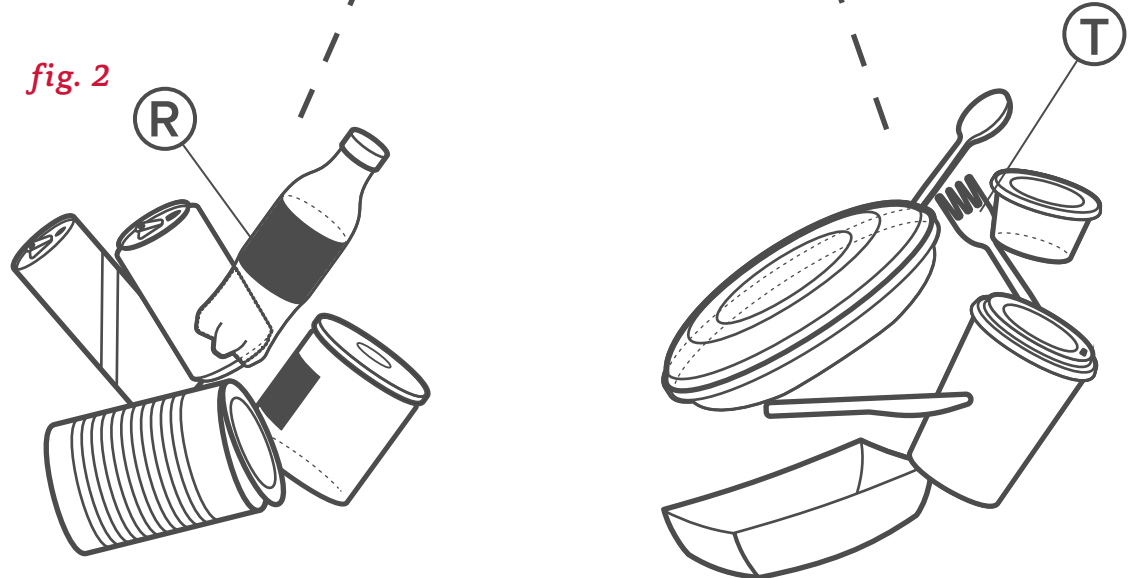

**3.** Go to the first floor and take your waste outside to the dumpster by the parking lot

**4.** Place trash and recycling in corresponding dumpsters

See fig. 3

fig. 3

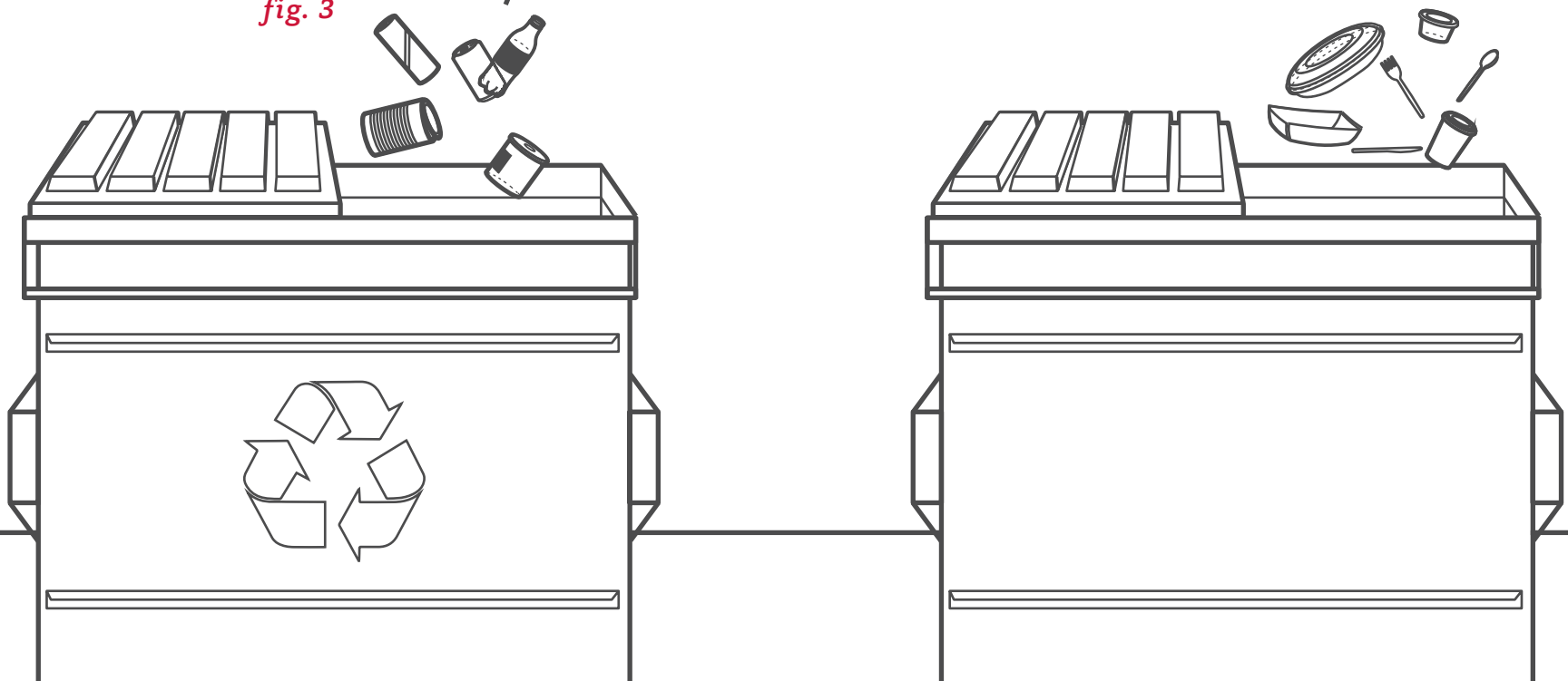

# SIEBERT HALL

## WASTE INSTRUCTIONS

**1.** Obtain garbage bags from your front desk for your personal trash can. Do not use for your recycling bin

See fig. 1

fig. 1



**2.** Separate trash from recycling

See fig. 2

fig. 2

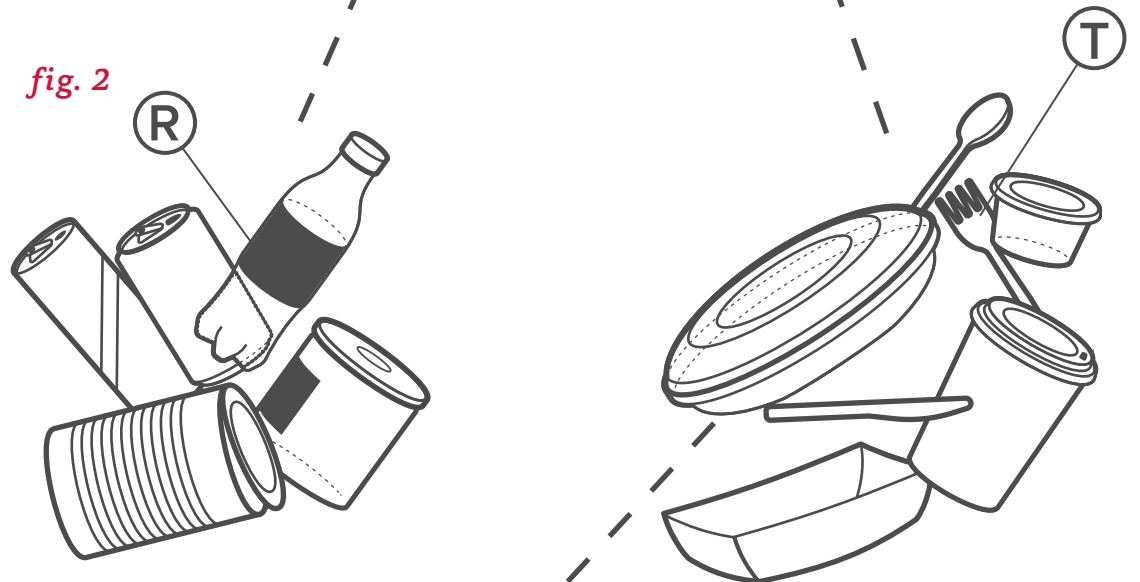

**3.** Go downstairs to the first floor and take your waste outside to the dumpster

**4.** Place recycling in **red** dumpster

**5.** Put trash in the side door of the blue compactor. Please do not put it on the top of the compactor; there is no opening there

See fig. 3

fig. 3

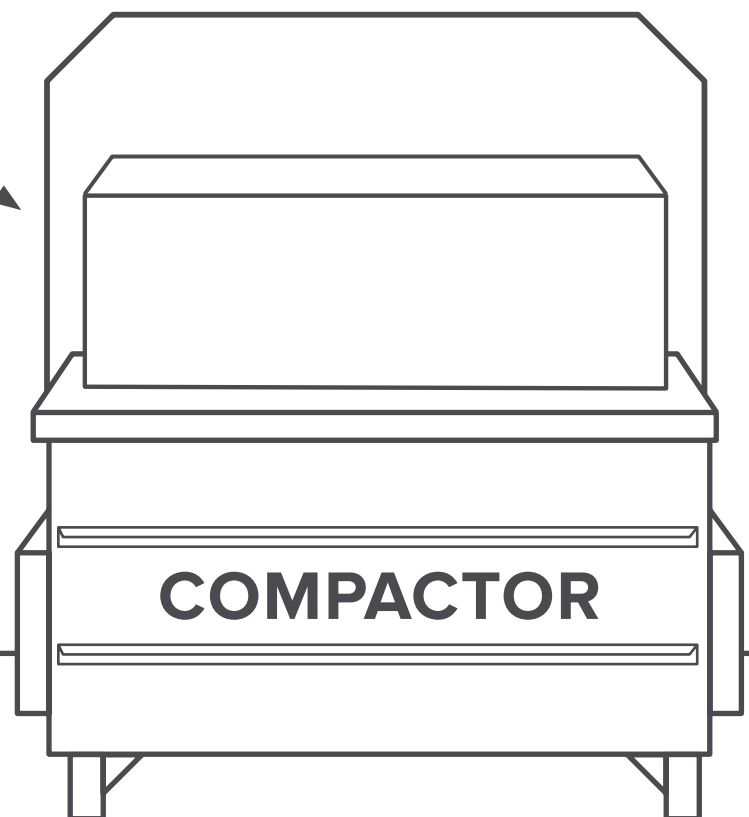
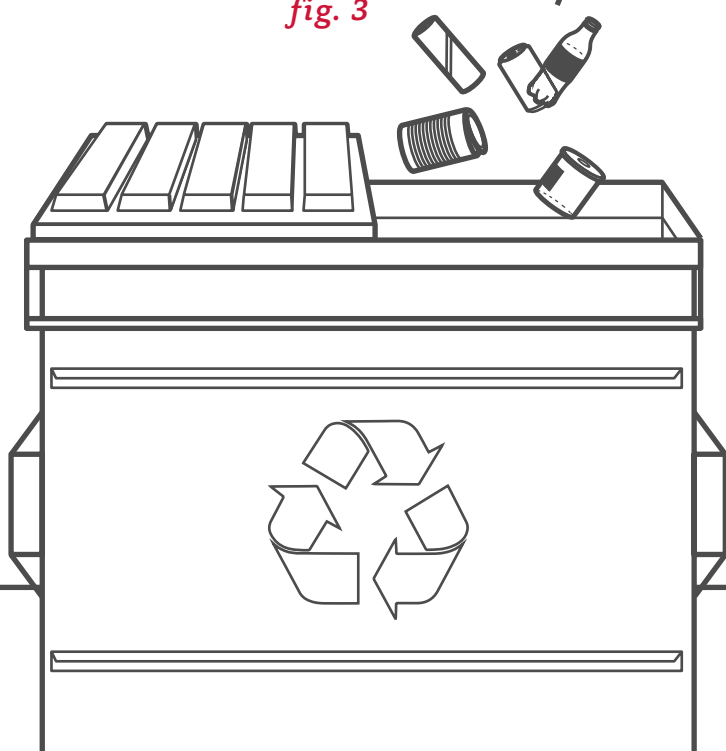

# SMITH-STEEB HALL

## WASTE INSTRUCTIONS

**1.** Obtain garbage bags from your front desk for your personal trash can. Do not use for your recycling bin

See fig. 1

fig. 1



**2.** Separate trash from recycling

See fig. 2

fig. 2

**3.** Go downstairs to the first floor and take your waste outside to the dumpster

**4.** Place recycling in **red** dumpster

**5.** Put trash in the side door of the blue compactor. Please do not put it on the top of the compactor; there is no opening there

See fig. 3

fig. 3

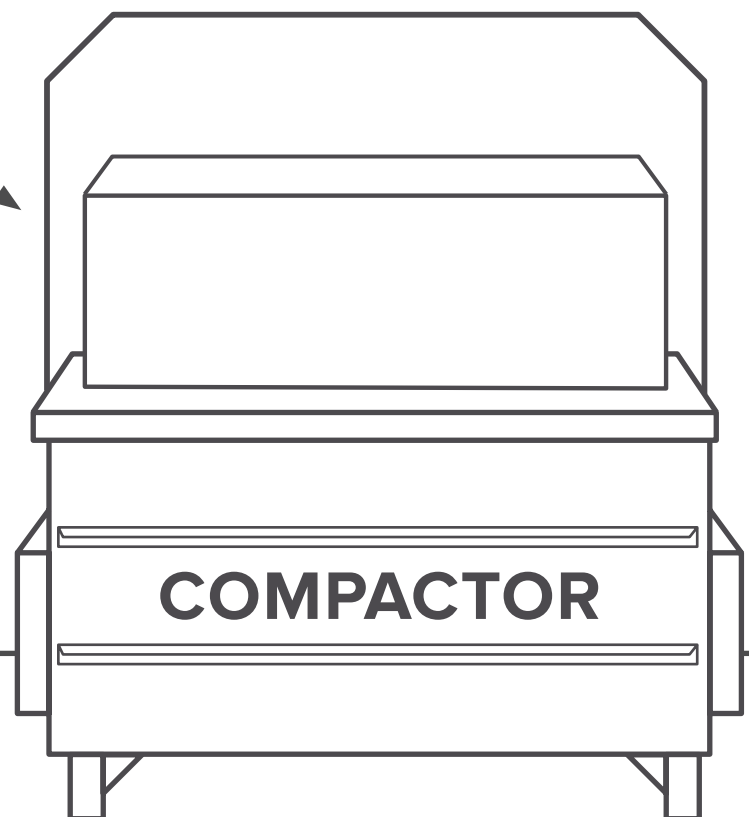
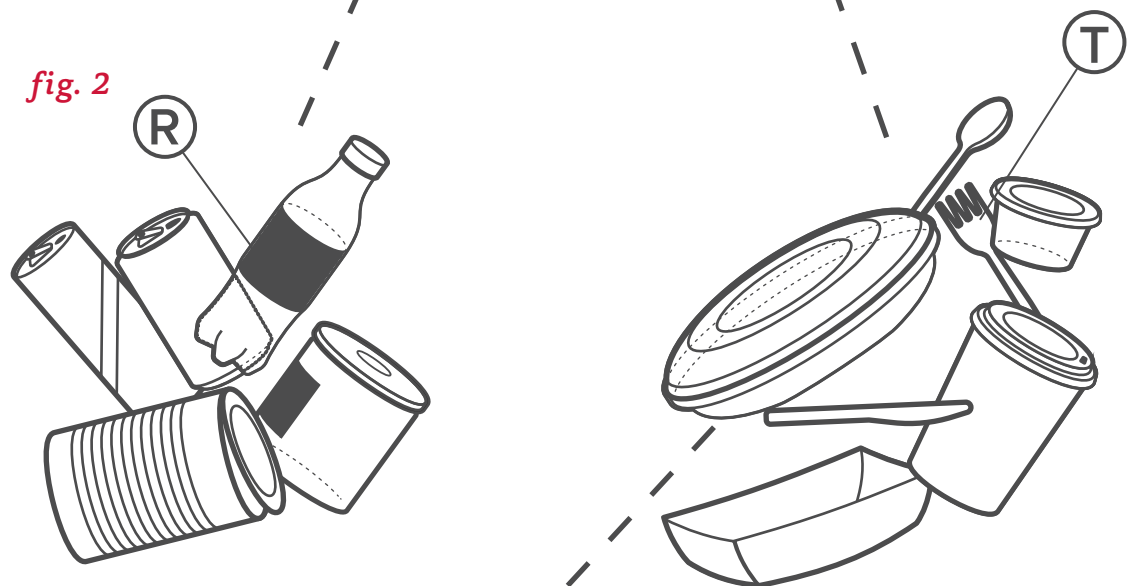
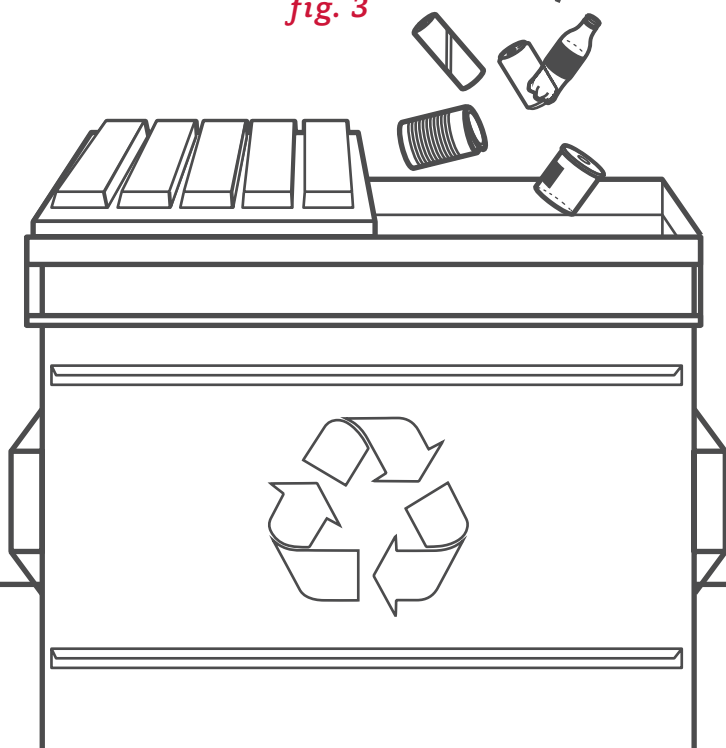

# RESIDENCE ON TENTH

## WASTE INSTRUCTIONS

**1.** Obtain garbage bags from your front desk for your personal trash can. Do not use for your recycling bin

See fig. 1

fig. 1



**2.** Separate trash from recycling

See fig. 2

fig. 2

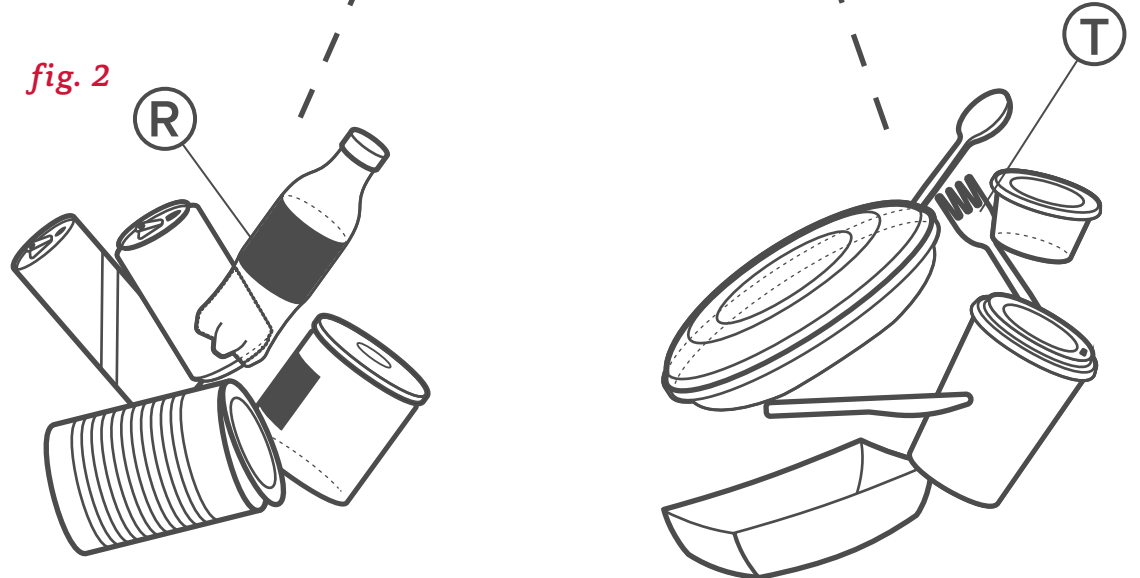

**3.** Go downstairs to the first floor and take your waste outside to the dumpster in the alley go past the bike room

**4.** Place trash and recycling in corresponding dumpsters

See fig. 3

fig. 3

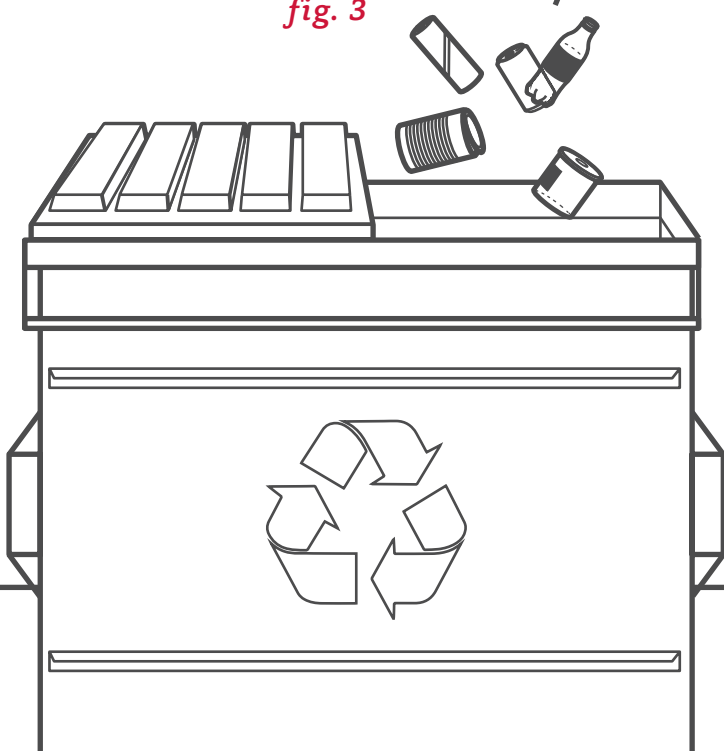

# WORTHINGTON BUILDING

## WASTE INSTRUCTIONS

**1.** Obtain garbage bags from the Neil building front desk (**1578 Neil Ave**) for your personal trash can. Do not use for your recycling bin

See fig. 1

fig. 1



**2.** Separate trash from recycling

See fig. 2

fig. 2

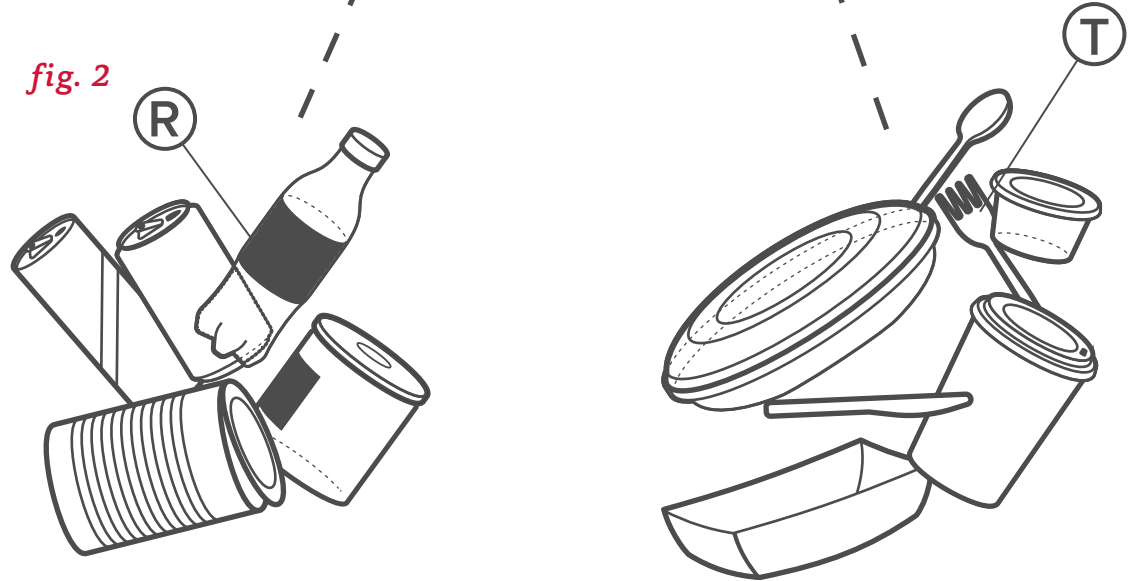

**3.** Go to the first floor and take your waste outside to the dumpster by the parking lot

**4.** Place trash and recycling in corresponding dumpsters

See fig. 3

fig. 3

